



moree®
ENHANCING AMBIANCE



ÜBER MOREE

ABOUT MOREE | A PROPOS DE MOREE

DE Moree ist Spezialist für hochwertige Leuchten, Leucht- und Objektmöbel, gemacht für Menschen, die sinnliches wie urbanes Wohnen schätzen. Aus der Liebe zu klaren Formen, innovativen Materialien und der Faszination für die Wirkung von Licht schöpfen die Moree Designer immer neue Ideen für ausdrucksstarkes wie zeitloses Interieur & Exterieur.

Moree steht für formschöne und hochfunktionale Qualitätsprodukte, welche im ausgesuchten Einrichtungs- und Designfachhandel in über 30 Ländern erhältlich sind.

Das Sortiment basiert zudem auf einer umfangreichen Kollektion an Leuchttischen und Sitzmöbeln für alle Anwendungsbereiche der Gastronomie und Hotellerie.

Unser Service und die schnelle Verfügbarkeit von Ersatzteilen ist nicht nur bei gewerblichen Kunden unentbehrlich. Wir achten bei der Konzeption von Produkten auf mögliche Verwendung von Austauschteilen und halten ein Ersatzteillager vor, das schnelle Reparaturen von Produkten ermöglicht.

Wir bieten die Möglichkeit, unsere Produkte individuell zu bedrucken und so Ihre Marke oder Botschaften prominent zu positionieren. >Individuell, aufmerksamkeitsstark und faszinierend.<

EN Moree is a specialist in high-quality lighting and furniture, made for people who appreciate sensual, urban living.

With the love of clear forms, innovative materials combined with a fascination for the effect of light, Moree designers are always exploring expressive and timeless ideas for interiors and exteriors.

Moree combines exquisite forms with highly functional products, available in over 30 countries in selected furnishing and design stores.

The range is based on an extensive collection of illuminated tables and seating for all areas of the hospitality industry.

Good service and the availability of spare parts is essential for both home and contract users. When designing products, we pay attention to the possible need for replacement parts and maintain a spare parts warehouse that enables quick product repairs.

Moree products can be branded individually, giving companies and product advertisements high visibility. >Unique, eye-catching and intriguing.<

FR Moree est un spécialiste des luminaires et des meubles de haute qualité conçus pour les personnes qui apprécient la vie sensuelle et urbaine.

Les designers de Moree s'inspirent de leur amour pour les formes claires, les matériaux innovants et de leur passion pour les jeux de lumière pour créer des intérieurs et extérieurs expressifs et intemporels.

Moree est signe de produits de qualité élégants et parfaitement fonctionnels qui sont proposés dans les magasins de meubles et de design de plus de 30 pays.

La gamme est basée sur une vaste collection de tables lumineuses et meubles d'assise pour tous les domaines d'application de la gastronomie et de l'hôtellerie.

Un bon service et la disponibilité rapide de pièces détachées ne sont pas seulement indispensables pour des clients commerciaux. Lors de la conception des produits, nous prêtons attention à l'utilisation possible de pièces de rechange et maintenons un entrepôt de pièces de rechange qui permet des réparations rapides des produits.

La possibilité d'appliquer des impressions individuelles sur nos produits afin de transporter des marques ou messages de manière exceptionnelle constitue un autre atout. >Individuels, attractifs et fascinants.<

MATERIALIEN

MATERIALS | MATERIAUX

DE Um das anspruchsvolle Qualitätsniveau und die Langlebigkeit der Produkte zu garantieren, werden ausschließlich hochwertige Materialien wie Stahl, Aluminium, Glas, Holzwerkstoffe und Filz verarbeitet. Die einzigartigen, transluzenten Komposit-Kunststoffe wurden exklusiv für Moree entwickelt und produziert.

Moree hat sich bewusst für den Produktionsstandort Deutschland entschieden. Das Design, die Entwicklung und die Herstellung werden somit hauptsächlich in Zusammenarbeit mit deutschen Partnern realisiert. Hohe Qualitätsstandards und kurze Lieferzeiten stehen im Vordergrund.

EN To guarantee the demanding level of quality and durability of our products, only high-quality materials such as steel, aluminum, glass, wood and felt are used. The unique, translucent polymer composites that we use have been developed and produced exclusively for Moree.

We have deliberately chosen Germany for the production location thus design and development are mainly in cooperation with German partners. High quality standards and short delivery times are our priority.

FR Nous garantissons le niveau de qualité et la durabilité de nos produits par l'emploi exclusif de matériaux de toute première qualité: acier, aluminium, verre, matériaux dérivés du bois, feutre. Les matières plastiques translucides uniques en leur genre sont développées et fabriquées pour Moree en exclusivité.

Moree a délibérément retenu l'Allemagne comme site de production. Le design, le développement et la fabrication sont donc pour la plupart assurés en collaboration avec des partenaires allemands. La priorité est accordée aux standards de qualité stricts et aux délais de livraison courts.



LICHT

LIGHT | LUMIÈRE

DE Erst durch Licht werden Farben, Materialien, Formen und die Dimension von Räumen visuell wahrnehmbar, der richtige Umgang mit Licht ist entscheidend für die Wirkung des Raumes. Zudem ist Licht wie kein anderes visuelles Medium in der Lage Emotionen zu beeinflussen.

Moree konzentriert sich auf innovative LED-Technologie in Symbiose mit seinen Produkten. Die LED-Module werden mittels Fernbedienung gesteuert und ermöglichen unzählige Farben, Helligkeiten und vielfältige Effekte auf Knopfdruck. Licht und Farbe eröffnen neue Gestaltungsdimensionen im Design und machen die Faszination der Moree-Produkte aus. Für den professionellen Einsatz können unsere LED multicolor Produkte mit DMX512 gesteuert werden. Auch in kabellosen Batterieprodukten.

EN Only through light can colours, materials, shapes and spaces be visually perceived, and light, like no other medium can influence your emotions in any situation. The correct handling of light is crucial for the effect in any environment.

Moree focuses on innovative LED technology in symbiosis with its products. The LED modules are remote controlled which enable endless colours, brightness and a variety of effects right at your fingertips. Light and colour are what make Moree products so intriguing, and open up new dimensions in our designs - enhancing ambience. For professional use, our LED multicoloured products can be controlled with DMX512. Also in wireless battery products.

FR Seule la lumière donne une âme aux couleurs, matériaux, formes et dimensions des intérieurs. Les effets qu'un intérieur peut produire dépendent largement de la gestion adéquate de la lumière. Et il ne faut pas oublier que la lumière n'a pas sa pareille parmi les médias visuels s'il s'agit d'influencer les émotions.

Moree se concentre sur la technologie DEL innovante en une symbiose parfaite avec ses produits. Les modules DEL sont télécommandables, d'innombrables couleurs, luminosités et effets variés peuvent ainsi être créés sur une simple pression de touche. La lumière et les couleurs ouvrent des horizons nouveaux au design et rendent les produits de Moree si fascinants. Pour un usage professionnel, nos produits LED multicolores peuvent être contrôlés avec DMX512. Également dans les produits de batterie sans fil.



INHALT

CONTENT | CONTENU

02

ÜBER MOREE
ABOUT MOREE
À PROPOS DE MOREE

04

MATERIALIEN & LICHT
MATERIAL & LIGHT
MATÉRIEL ET LUMIÈRE

08

MÖBEL
FURNITURE
MEUBLES

50

LEUCHTEN
LIGHTING
LUMIÈRES

72

PROJEKTE
PROJECTS
PROJETS

74

TECHNISCHE DATEN
TECHNICAL DATA
CARACTÉRISTIQUES
TECHNIQUES



08

ED | ED TABLE



14

ED STATIC

NEW



18

DAVE

NEW



36

LOUNGE 45|55|75|105
LOUNGE M 45|55|75|105



42

STUDIO 36|45|75|105



44

COOLER



54

LOUIS



56

ISA-BELLE

NEW



58

SWAP 150



22

AIR COLLECTION

NEW

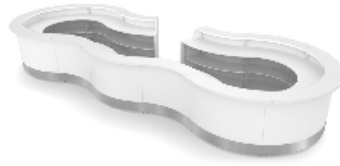

24

LED BARS | LED COUNTERS



32

ORA HOME



34

LOUNGE | VARIATION



46

BUBBLE | CUBE



50

EMILY 38 & 54

NEW



52

SPOTE

NEW



60

ALICE | XL | 30 | 50



66

SHARK



68

STAR 40 | 60



70

9 W RGBW | 11 W CCT

ED 45 | 75 | 105

- Tisch mit robuster HPL-Tischplatte
- Perfekte Kombination mit ED Barhocker

- Table with robust HPL table top
- Perfect combination with ED barstool

- Table avec plateau HPL robuste
- Combinaison parfaite avec le tabouret ED

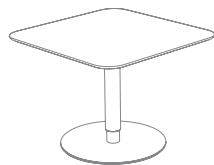
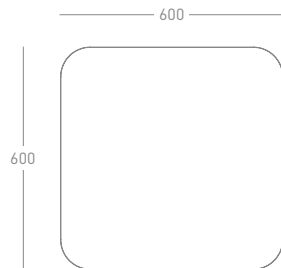

ED 45 | 600 x 600 x H450



ED 75 | 600 x 600 x H750

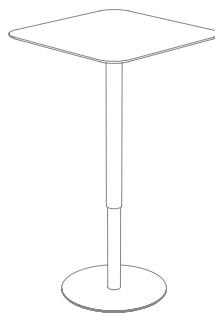

ED 105 | 600 x 600 x H1050

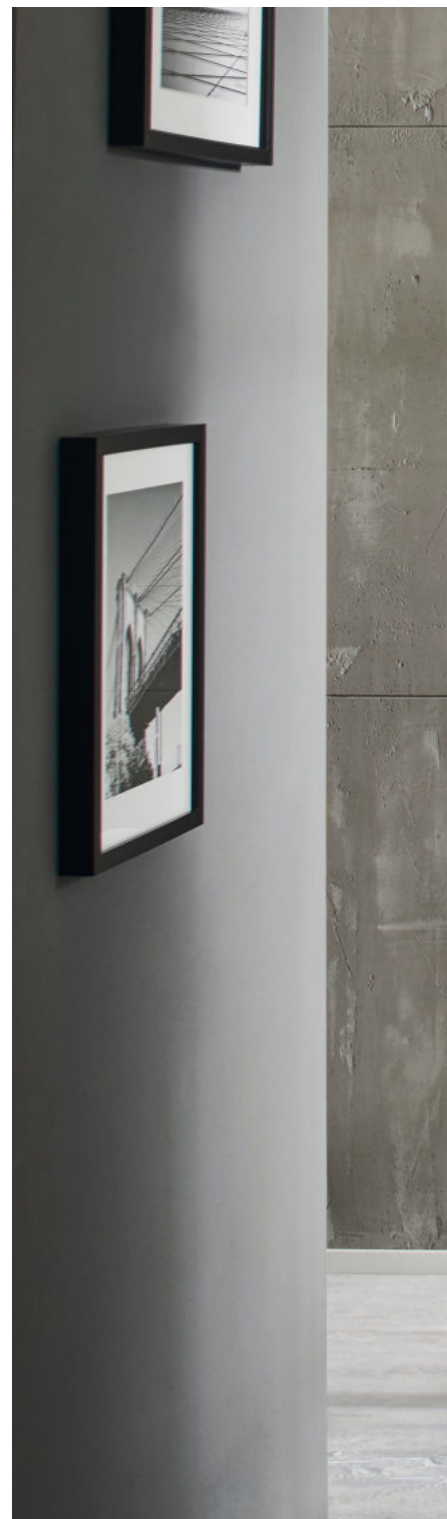



ED WHITE

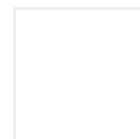
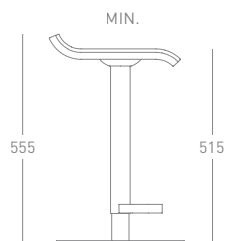
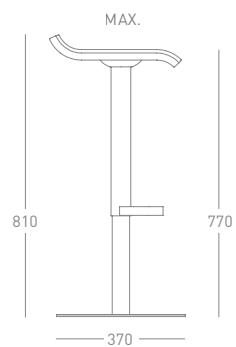
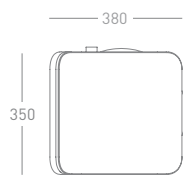

Weiß/
White/
Blanc

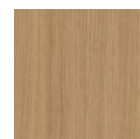

Eiche/
Oak/
Chêne



Walnuss/
Walnut/
Noyer

- Höhenverstellbar
- Im Sitz integrierter Stellhebel
- 360° Rotation des Sitzes

- Adjustable seat height
- In seat integrated lever
- 360 degree rotating seat

- La hauteur d'assise est réglable
- Levier intégré dans le siège
- Pivotant à 360 degrés



ED White-White | Mod. 13-02-03



ED White-Oak | Mod. 13-02-31



ED White-Walnut | Mod. 13-02-32



ED ANTHRACITE

- Höhenverstellbar
- Im Sitz integrierter Stellhebel
- 360° Rotation des Sitzes

- Adjustable seat height
- In seat integrated lever
- 360 degree rotating seat

- La hauteur d'assise est réglable
- Levier intégré dans le siège
- Pivotant à 360 degrés

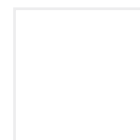
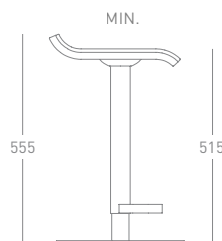
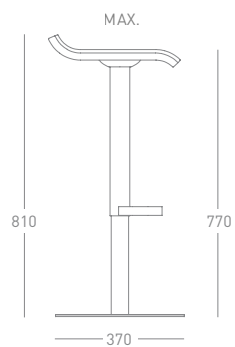
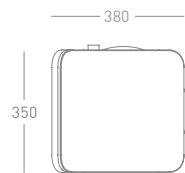

Weiß/
White/
Blanc



Anthrazit/
Anthracite/
Anthracite



Eiche/
Oak/
Chêne



Walnuss/
Walnut/
Noyer



ED Anthracite-White | Mod. 13-02-01



ED Anthracite-Oak | Mod. 13-02-11



ED Anthracite-Walnut | Mod. 13-02-12



ED STATIC WHITE

- Mehrere Sitzdesigns erhältlich
- Barhockersitz Dave auch montierbar

- Several seat designs available
- Barstool seat Dave also mountable

- Plusieurs designs de sièges disponibles
- Siège de tabouret de bar Dave également montable

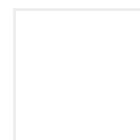
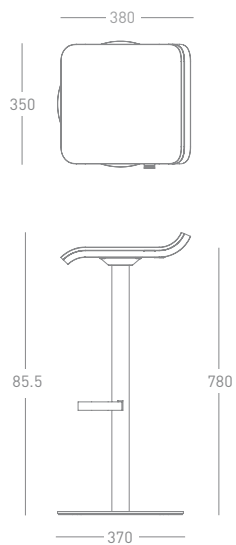

Weiß/
White/
Blanc



Eiche/
Oak/
Chêne



Walnuss/
Walnut/
Noyer



ED STATIC White-White | Mod. 13-01-03



ED STATIC White-Oak | Mod. 13-01-31



ED STATIC White-Walnut | Mod. 13-01-32



ED STATIC ANTHRACITE

- Mehrere Sitzdesigns erhältlich
- Barhockersitz Dave auch montierbar

- Several seat designs available
- Barstool seat Dave also mountable

- Plusieurs designs de sièges disponibles
- Siège de tabouret de bar Dave également montable

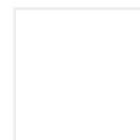
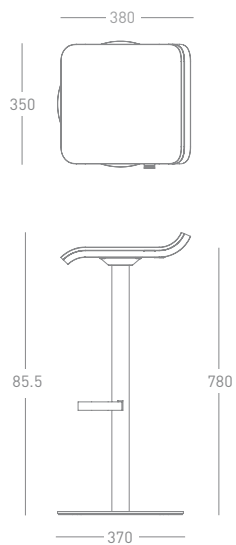

Weiß/
White/
Blanc



Anthrazit/
Anthracite/
Anthracite



Eiche/
Oak/
Chêne



Walnuss/
Walnut/
Noyer



ED STATIC Anthracite-White | Mod. 13-01-01



ED STATIC Anthracite-Oak | Mod. 13-01-11



ED STATIC Anthracite-Walnut | Mod. 13-01-12



DAVE WHITE

Stoffbezug aus 98%
recyceltem Material
Fabric cover made from
98% recycled material
Housse en tissu à 98% de
matières recyclées

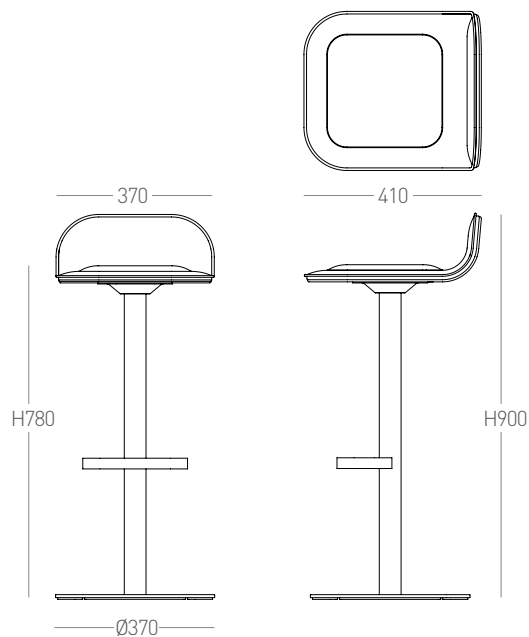

DAVE White/Light Grey
Mod. 42-01-01



DAVE White/Anthracite
Mod. 42-01-02



DAVE White/Sage
Mod. 42-01-03



DAVE White/Win Red
Mod. 42-01-04





DAVE ANTHRACITE

Stoffbezug aus 98%
recyceltem Material
Fabric cover made from
98% recycled material
Housse en tissu à 98% de
matières recyclées

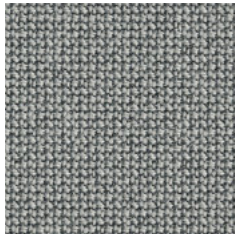

Hellgrau/
Light Grey/
Gris clair



Anthrazit/
Anthracite/
Anthracite

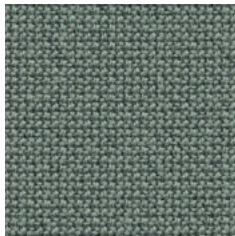

Salbei/
Sage/
Sauge

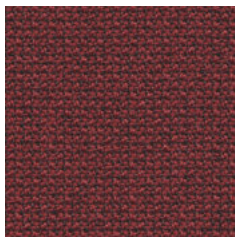

Weinrot/
Wine Red/
Lie de Vin

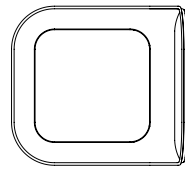

410

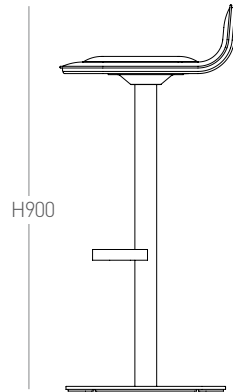

H900

370

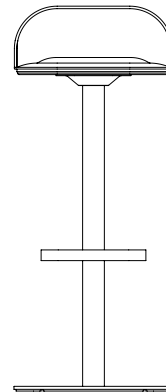

H780

Ø370



DAVE Anthracite/Light Grey Mod. 42-02-01



DAVE Anthracite/Anthracite Mod. 42-02-02



DAVE Anthracite/Sage Mod. 42-02-03



DAVE Anthracite/Wine Red Mod. 42-02-04

AIR - OUTDOOR COLLECTION



Weiß
White
Blanc



Anthrazit/Holz
Anthracite/Wood
Anthracite/Bois



Anthrazit
Anthracite
Anthracite

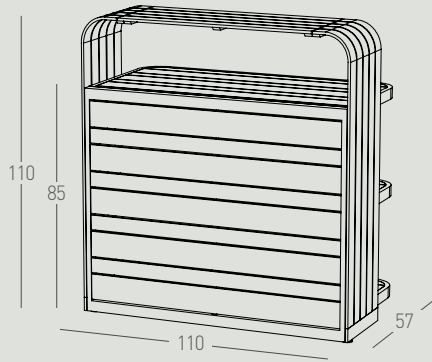

OUTDOOR BARSTOOL
 WHITE
 MOD. 45-01-03

OUTDOOR BARSTOOL
 ANTHRACITE
 MOD. 45-02-03

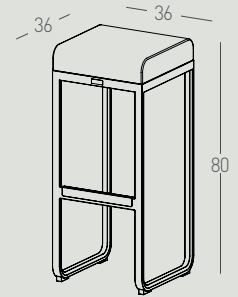

OUTDOOR BAR
 WHITE
 MOD. 45-01-01

OUTDOOR BAR
 ANTHRACITE
 MOD. 45-02-01

OUTDOOR BAR
 ANTHRACITE/WOOD (POLYSTYRENE)
 MOD. 45-03-01

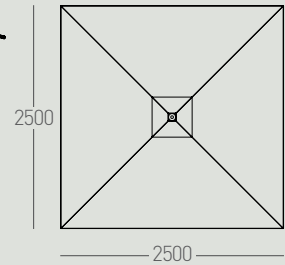
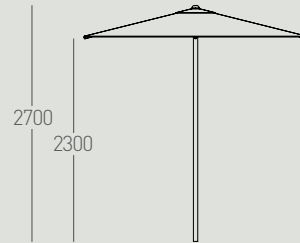

PARASOL
 WHITE/LIGHT GREY
 MOD. 45-01-04

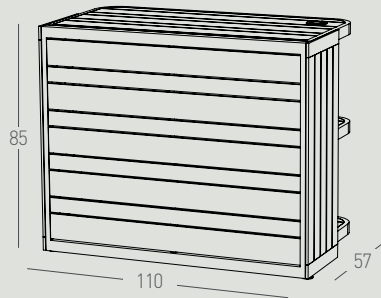

OUTDOOR BUFFET
 WHITE
 MOD. 45-01-02

OUTDOOR BUFFET
 ANTHRACITE
 MOD. 45-02-02

OUTDOOR BUFFET
 ANTHRACITE/WOOD (POLYSTYRENE)
 MOD. 45-03-02

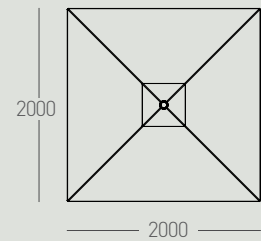
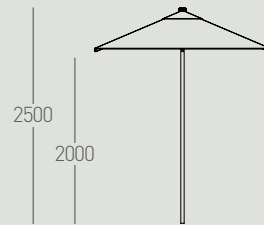

PARASOL
 ANTHRACITE/WOOD (POLYSTYRENE)
 MOD. 45-02-04

MODULAR BAR

- Umfangreiche Auswahl an Modulen
 - Alle Theken-Module kombinierbar
 - Duale Front- und Rückbeleuchtung individuell steuerbar
 - Umfangreiche Farb-, Material- & Zubehörauswahl
-
- Extensive range of modular elements available
 - All Bar modules combinable
 - Dual front and back lighting individually controllable
 - Extensive choice of colors, materials & accessories
-
- Grosse gamme de modules disponibles
 - Tous les modules de bar combinables
 - Double éclairage avant et arrière individuellement contrôlable
 - Large choix de couleurs, matériaux et accessoires

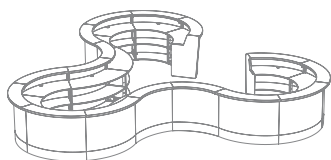
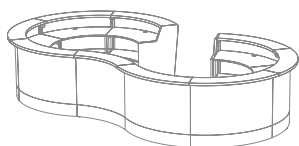
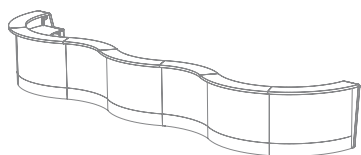

Mehr Informationen in unsrerem Thekenkatalog online

Please read our bar catalogue online

Plus d'informations dans le catalogue en ligne

www.moree.de/moree-bar-catalogue/







MODULAR BAR

- Umfangreiche Auswahl an Modulen
 - Alle Theken-Module kombinierbar
 - Duale Front- und Rückbeleuchtung individuell steuerbar
 - Umfangreiche Farb-, Material- & Zubehörauswahl
-
- Extensive range of modular elements available
 - All Bar modules combinable
 - Dual front and back lighting individually controllable
 - Extensive choice of colors, materials & accessories
-
- Grosse gamme de modules disponibles
 - Tous les modules de bar combinables
 - Double éclairage avant et arrière individuellement contrôlable
 - Large choix de couleurs, matériaux et accessoires

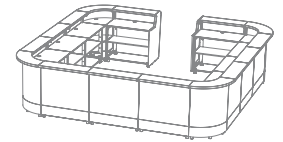
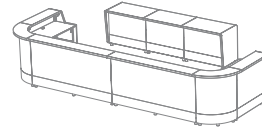
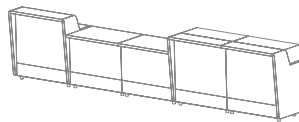

Mehr Informationen in unserem Thekenkatalog online
Please read our bar catalogue online
Plus d'informations dans le catalogue en ligne
www.moree.de/moree-bar-catalogue/

60° COUNTER

- 2 Versionen erhältlich: RADIUS & EDGE
- Duale Front- und Rückbeleuchtung individuell steuerbar
- Umfangreiche Farb-, Material- & Zubehörauswahl
- Komplett montiert inkl. Endstücken, nicht-modular

- 2 versions available: RADIUS & EDGE
- Dual front and back lighting individually controllable
- Extensive choice of colors, materials & accessories
- Fully assembled, non-modular

- 2 versions disponibles: RADIUS & EDGE
- Double éclairage avant et arrière individuellement contrôlable
- Large choix de couleurs, matériaux et accessoires
- Entièrement assemblé, non modulaire

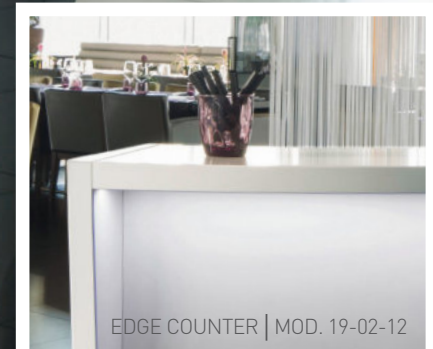
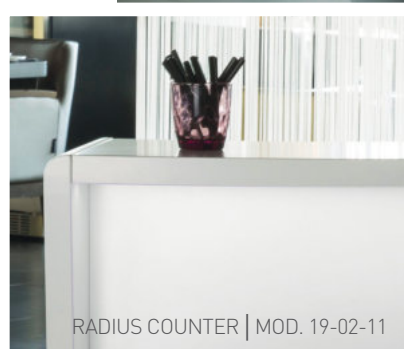
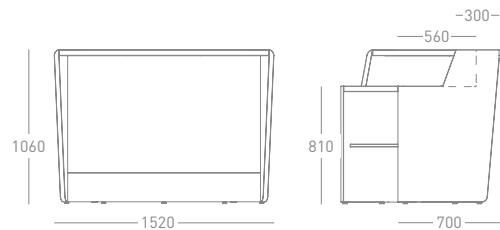





1M COUNTER

- 2 Versionen erhältlich: RADIUS & EDGE
- Duale Front- und Rückbeleuchtung individuell steuerbar
- Umfangreiche Farb-, Material- & Zubehöerauswahl
- Komplett montiert inkl. Endstücken, nicht-modular

- 2 versions available: RADIUS & EDGE
- Dual front and back lighting individually controllable
- Extensive choice of colors, materials & accessories
- Fully assembled, non-modular

- 2 versions disponibles: RADIUS & EDGE
- Double éclairage avant et arrière individuellement contrôlable
- Large choix de couleurs, matériaux et accessoires
- Entièrement assemblé, non modulaire

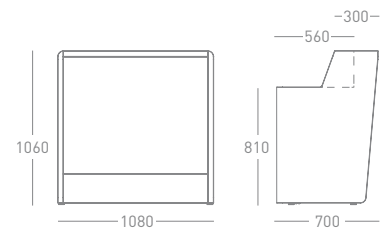



- LED-Beleuchtung RGB/Warmweiß
- Mit stylischem Stauraum
- Auch ohne Beleuchtung erhältlich

- LED lighting RGB/Warm white
- Stylish Storage Space
- Also available without light

- Éclairage LED RGB/Blanc chaud
- Espace de stockage élégant
- Également disponible sans lumière

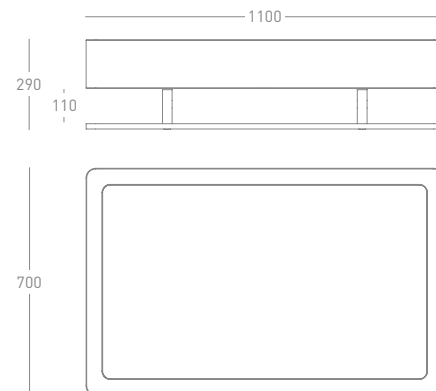

LOUNGE

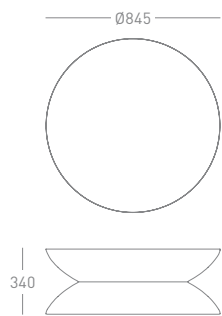



LOUNGE VARIATION

- Wandleuchte oder beleuchteter Loungetisch
- Wall light or illuminated lounge table
- Applique murale ou table de salon éclairée

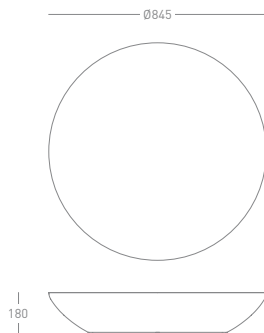

- 180 -





LOUNGE 45 | 55 | 75 | 105

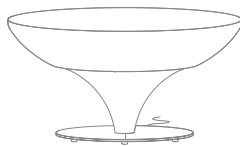

45 | Ø 845 x H450

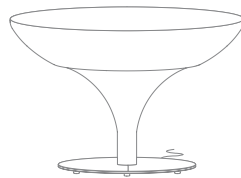

55 | Ø 845 x H550



75 | Ø 845 x H750



105 | Ø 845 x H1050



LOUNGE M 45 | 55 | 75 | 105

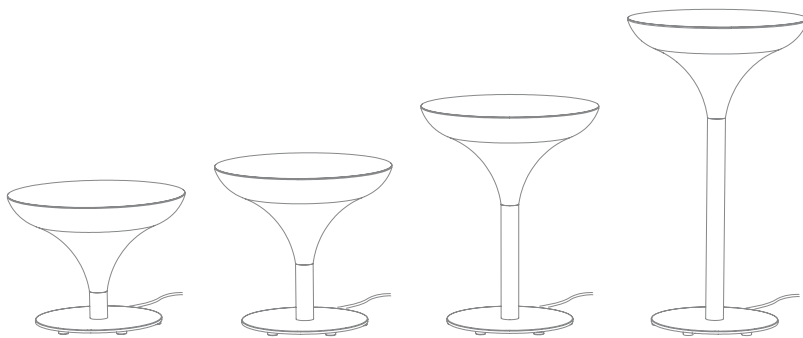

45 | Ø 600 x H450

55 | Ø 600 x H550

75 | Ø 600 x H750

105 | Ø 600 x H1050





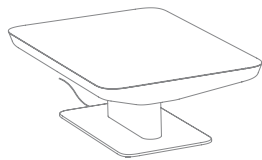

36 | 700 x 1000 x H360

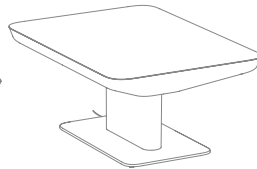

45 | 700 x 1000 x H450

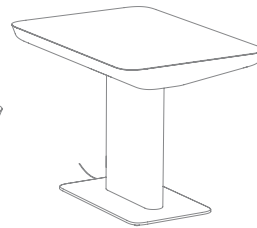

75 | 700 x 1000 x H750

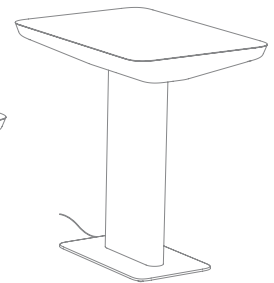

105 | 700 x 1000 x H1050

COOLER

- Für Indoor- und Outdoor Anwendungen
 - IP 64, spritzwassergeschützt
 - Ideal für Home & Contract
 - Multicolour LED-Einheit mit aufladbarem Akku
 - Mit IR-Fernbedienung
 - Leicht wechselbare, wiederaufladbare LED-Einheit (1)
 - LED-Einheit mit Schnellwechsel-Magnetverschluß
-
- For indoor and outdoor use
 - IP 64, splash-proof
 - Ideal for Home & Contract
 - Multicolour LED unit with rechargeable battery
 - With IR remote control
 - Easily exchangeable & rechargeable LED unit (1)
 - LED unit with quick-change magnetic lock
-
- Pour une utilisation intérieure et extérieure
 - IP 64, résistant aux éclaboussures
 - Idéal pour la maison et le contrat
 - Unité LED multicolore avec batterie rechargeable
 - Avec télécommande IR
 - Unité LED (1) facilement remplaçable et rechargeable
 - Unité LED avec serrure magnétique à changement rapide

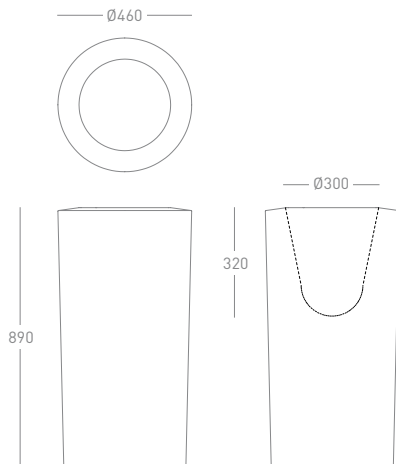



BUBBLE

- Beleuchteter Sitz & Tisch
- Dekoratives Leuchtobjekt
- Mit Akku oder 230 V Zuleitung
- Für Innenbereich oder Außenbereich
- Inklusive Glasplatte oder Kissen

- Illuminated seat & table
- Decorative illuminant
- With rechargeable battery or 230 V supply line
- For indoor or outdoor use
- Including glass top or cushion

- Siège et table éclairés
- Illuminant décoratif
- Avec batterie ou câble d'alimentation 230 V
- Pour l'intérieur ou l'extérieur
- Y compris: plaque de verre ou coussin

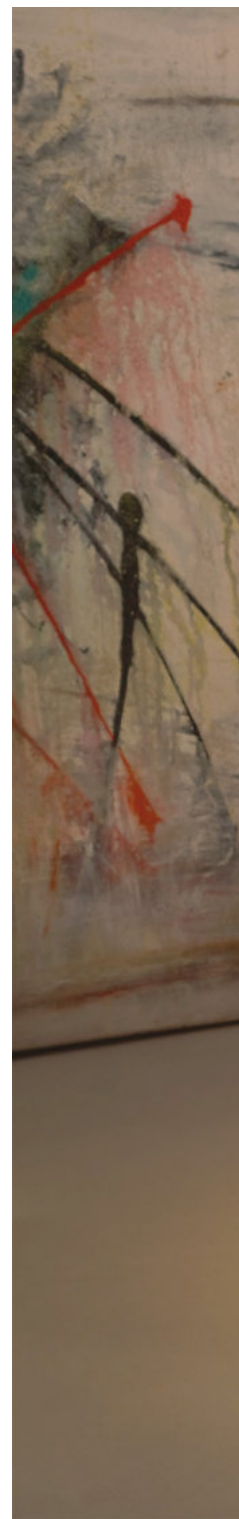
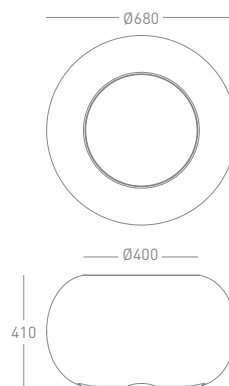





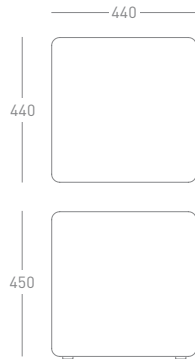

- Innovatives Sitzmöbel und Tisch
- Dekoratives Leuchtobjekt
- Mit Akku oder 230 V Zuleitung
- Für Innenbereich oder Außenbereich
- Zubehör optional: Glasplatte oder Kissen

- Innovative seat and table
- Decorative illuminant
- With rechargeable battery or 230 V supply line
- For indoor or outdoor use
- Optional accessory: glass top or cushion

- Siège et table innovants
- Illuminant décoratif
- Avec batterie ou câble d'alimentation 230 V
- Pour l'intérieur ou l'extérieur
- Accessoires optionnels: plaque de verre ou coussin



EMILY M / EMILY L

- Verwendung Indoor & Outdoor
- Kabellos, mit wiederaufladbarem Li-Ion Akku
- Aufladen per Ladestation mit USB-Netzteil
- Mit Ladekontrollleuchte (rot=laden, grün=aufgeladen)
- EIN/AUS-Berührungsschalter
- Stufenlos dimmbar

- Indoor & outdoor use
- Cordless, with rechargeable Li-Ion battery
- Charging on charging station via USB power supply unit
- With charging indicator light (red=charging, green=charged)
- ON/OFF touch switch
- Continuously dimmable

- Utilisation intérieure et extérieure
- Sans fil, avec batterie Li-Ion rechargeable
- Recharge sur la station de chargement par adaptateur secteur USB
- Avec indicateur de charge (rouge=charge, vert=chargé)
- Interrupteur tactile ON/OFF
- Gradation en continu



EMILY | 46-01-38



EMILY | 46-01-54



Ladestation
Charging Station
Station de chargement



Laden auf Ladestation
Charging on Station
Charge sur la station de charge



LED LIGHTING



SPOT.E | SOLAR SPOT

- Aufladen per Solarpanel
- Beleuchteter Ein/Aus Schalter
- Automatisches Ein-/Ausschalten durch Helligkeitssensor bei 20-30 Lux
- schwenkbarer Lampenkopf
- Befestigung per Erdspieß oder M6 Schraube auf Unterseite

- Charging via solar panel
- Illuminated ON/OFF switch
- Automatic ON/OFF by brightness sensor at 20-30 lux
- Swivel lamp head
- Mounting by ground spike or M6 screw on underside

- Chargement par panneau solaire
- Interrupteur marche/arrêt éclairé
- Mise en marche/arrêt automatique par capteur de luminosité à 20-30 lux
- Tête de lampe pivotante
- Fixation par piquet de terre ou vis M6 sur la face inférieure



SPOT.E | 43-01-01





LOUIS | SOLAR LANTERN

>DUALES AUFLADEN< DURCH SOLARMODUL & LADEGERÄT

- Verwendung Indoor- und Outdoor
- Aluminium pulverbeschichtet für den Aussenbereich
- Wiederaufladbarer Li-Ion Akku
- Mit Ladekontrollleuchte
- Warmweisse LEDs (3000K/238lm)
- Betriebszeit ca. 9 Std.
- LEDs dimmbar

>DUAL CHARGING< BY SOLAR MODULE & ADAPTER

- Use indoor and outdoor
- Powder-coated aluminum for outdoor use
- Rechargeable Li-ion battery
- With charge indicator light
- Warm white LEDs (3000K/238lm)
- Operating time approx. 9 hours
- LEDs dimmable

>DOUBLE CHARGE< PAR MODULE SOLAIRE & CHARGEUR

- Utiliser à l'intérieur et à l'extérieur
- Aluminium enduit de poudre pour usage extérieur
- Batterie Li-ion rechargeable
- Avec voyant de charge
- LED blanc chaud (3000K/238lm)
- Durée de fonctionnement env. 9 h
- DEL dimmable



LOUIS | MOD. 38-01-36



LOUIS | MOD. 38-02-36





ISABELLE | SOLAR FLOOR & ARC LAMP (2IN1)

>2IN1 FUNKTION<

- Solar-Stehleuchte & Bogenleuchte in Einem
- für den Aussenbereich
- Wiederaufladbarer Li-Ion Akku
- Laden per Solarpanel oder Adapter
- Warmweisse LEDs (3000 K/800 lm)
- LEDs dimmbar
- Betriebszeit 8-20 Std

>2IN1 FUNCTION

- Solar floor lamp & arc lamp in one
- for outdoor use
- Rechargeable Li-Ion battery
- Charging via solar panel or adapter
- Warm white LEDs (3000 K/800 lm)
- LEDs dimmable
- Operating time 8-20 hours

>1EN1 FONCTION<

- Lampe à pied solaire et lampe à arc en un
- pour l'extérieur
- Batterie Li-Ion rechargeable
- Chargement par panneau solaire ou adaptateur
- LED blanc chaud (3000 K/800 lm)
- DEL à intensité variable
- Durée de fonctionnement 8-20 heures



ISA-BELLE | MOD. 44-01-01





moree | LIGHTING



SWAP 150

- Outdoor- und Indoorleuchte in Höhe 150 cm
 - Standard-Leuchte mit weiß-transluzentem PE-Schirm (ohne Designschirm-Aufsatz)
 - Zubehör: wechselbare Design-Schirme
 - Oder Gewebeschirm, grau beschichtet
-
- Indoor & outdoor lamp in height 150 cm
 - Standard lamp with white translucent PE shade (without design shade cover)
 - Accessories: swappable design shades
 - Or with grey coated fabric shade
-
- Lampe intérieure et extérieure en hauteur 150 cm
 - Luminaire standard avec abat-jour PE blanc translucide (sans des abat-jour design couverture)
 - Accessoires: des abat-jours design interchangeableables
 - Ou avec un abat-jour en tissu enduit gris



31-01-150

31-02-150

31-03-150

31-04-150

31-05-150

31-06-150

31-00-150



MOD. 31-06-01

Grauer Gewebeschirm-Aufsatz

MOD. 31-06-01

Grey coated fabric shade cover

MOD. 31-06-01

Abat-jour couverture en tissu enduit gris



ALICE

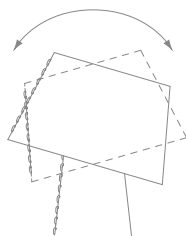
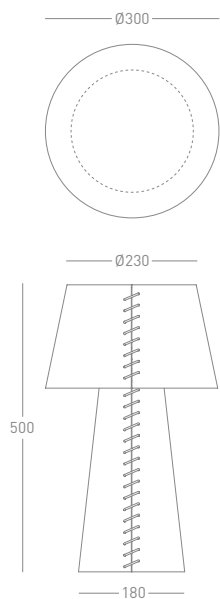

- Mit schwenkbarem Schirm
- With tiltable head
- Avec tête inclinable





ALICE XL

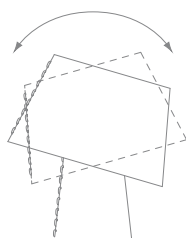
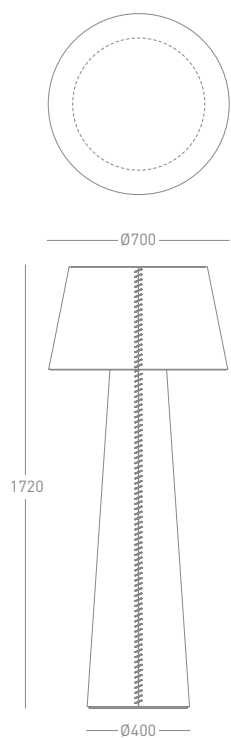

- Mit schwenkbarem Schirm
- With tiltable head
- Avec tête inclinable





ALICE 30 | ALICE 50

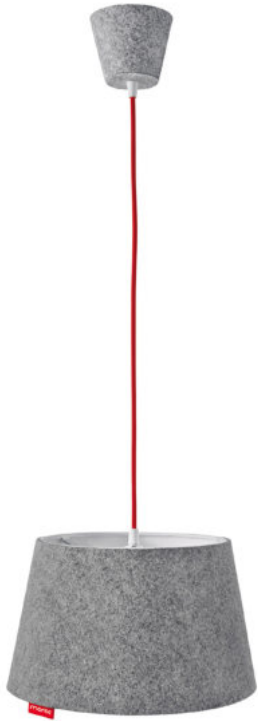
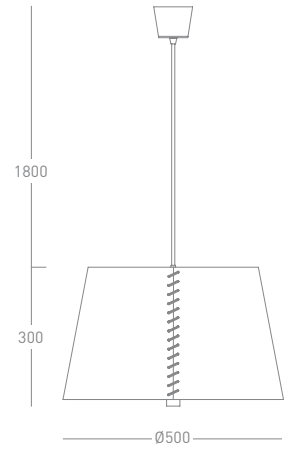
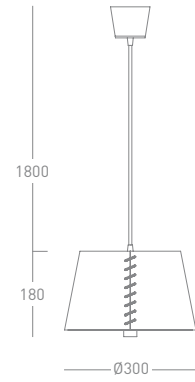





- Dekoratives Leuchtobjekt
- Mit Akku oder 230 V Zuleitung
- Für Innenbereich oder Außenbereich
- Decorative illuminant
- With rechargeable battery or 230 V supply line
- For indoor or outdoor use
- Illuminant décoratif
- Avec batterie ou câble d'alimentation 230 V
- Pour l'intérieur ou l'extérieur

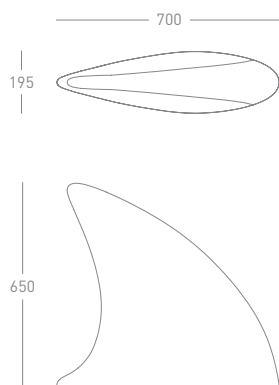

STAR 40 | STAR 60

- Stern in 2 Größen für Innen & Aussen
 - Multicolor LED-Einheit mit Fernbedienung
 - Version mit Ladegerät & Akku für kabellosen Betrieb
 - Alternative Version mit 230 V Outdoorkabel erhältlich
 - Integrierte Wandaufhängung
 - Erdspieß zur Bodenbefestigung
- Star in 2 sizes for inside & outside
 - Multicolour LED unit with remote control
 - Version with charger and battery for wireless operation
 - Alternatively 230 V outdoor cable version available
 - Integrated wall suspension
 - Ground spike for ground mounting
- Étoile en 2 tailles pour l'intérieur et l'extérieur
 - Unité LED multicolore avec télécommande
 - Inclus chargeur et batterie pour le fonctionnement sans fil
 - Autre version de câble extérieure 230 V disponible
 - Suspension murale intégrée
 - Pointe au sol pour montage au sol

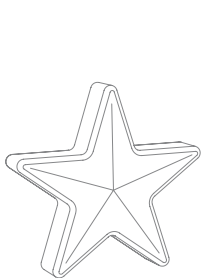
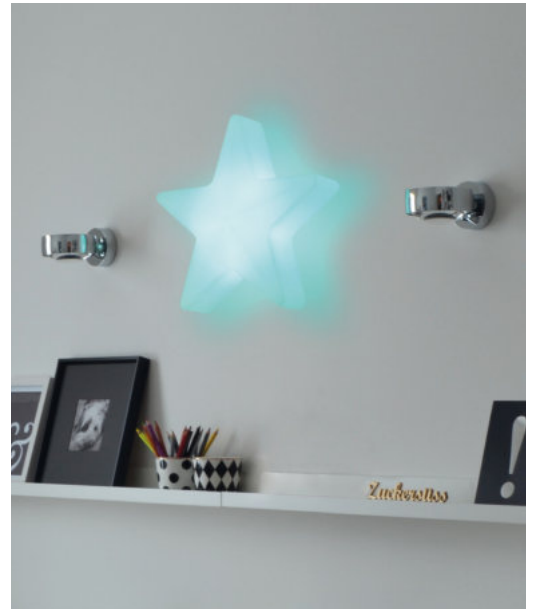

STAR 40 | 410 x 100 x H 400

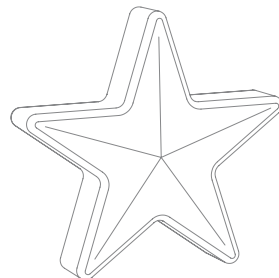

STAR 60 | 570 x 130 x H 550

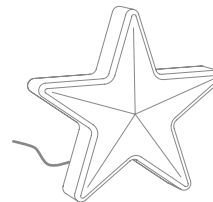

STAR 40 | 410 x 100 x H 400

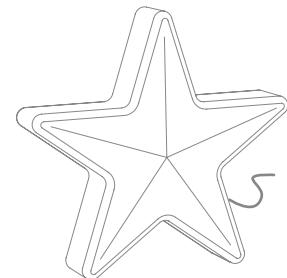

STAR 60 | 570 x 130 x H 550



11W E27 RGB CCT WIFI BULB

FUNKTIONEN

- Steuerung per MOREE REMOTE APP
- Kompatibel mit Google Assistant und Amazon Echo über Sprachsteuerung
- Szenen- und Farbprogramme
- Farben: RGB-Spektrum+CCT
- Licht von Warm- bis Kaltweiß einstellbar
- Eingebautes WLAN-Modul
- Zeitschalter per App
- Dimm-Funktion per App

FUNCTIONS

- Control via MOREE REMOTE APP
- Works with Google Assistant & compatible with Amazon Alexa
- Scene and colour programmes
- Colours: RGB Spectrum+CCT
- Warm to cold white adjustable
- Built in wifi controller
- Timing switch via app
- Dimming function via App

FONCTIONS

- Contrôle via MOREE REMOTE APP
- Compatible avec Google Assistant et Amazon Alexa via contrôle vocal
- Programmes de scènes et de couleurs
- Couleurs: RGB Spectrum+CCT
- Chaud à blanc froid réglable
- Module WIFI intégré
- Interrupteur de synchronisation via l'application
- Fonction de variation via l'app



Mod. 20-03-01



MOREE MOBILE
REMOTE APP



9W E27 RGBW MULTICOLOUR BULB

FUNKTIONEN

- Steuerbar mit Fernbedienung (Mod.20-02-02)
- 9 Programme
- Dimmfunktion
- Das gesamte RGB-Spektrum
- Warm-weißes Licht
- 4-Kanal-Steuerung
- Reichweite bis zu 25 m

FUNCTIONS

- Controllable with Remote (Mod.20-02-02)
- 9 Programmes
- Brightness control
- The entire RGB spectrum
- White light, warm setting
- 4 Channel controls
- A range of up to 25 m

FONCTIONS

- Contrôlable avec la télécommande (Mod.20-02-02)
- 9 programmes
- L'ensemble du spectre RVB
- Lumière blanche
- Contrôle d'intensité
- 4 Channel controls
- Portée jusqu'à 25 m



Mod. 20-02-02



Mod. 20-02-01



PROJEKTE

PROJECTS | PROJETS

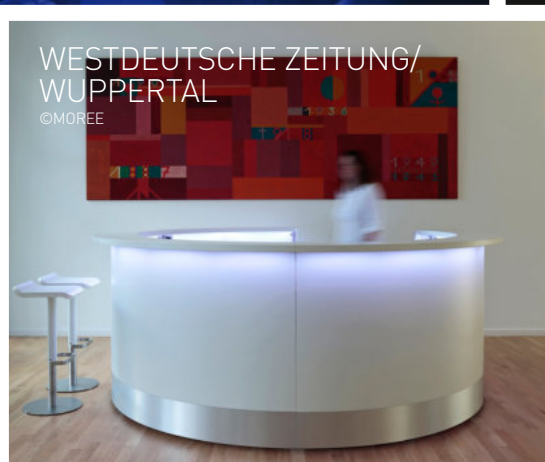



MOODIS LOUNGE BAR /
KORTRIJK, BELGIEN
©LAURENT-PERRIER.DE

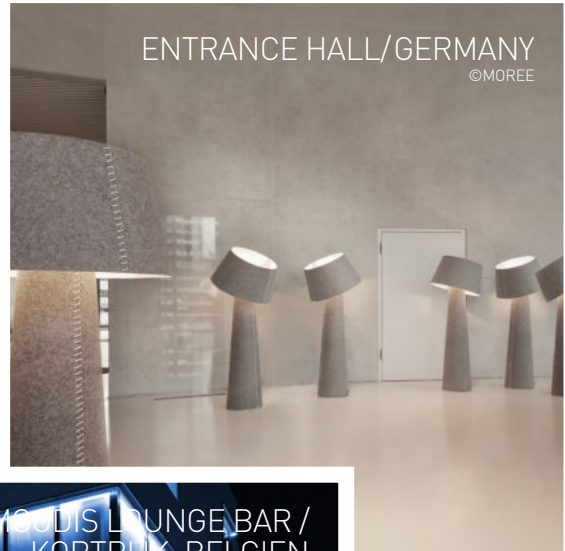

ENTRANCE HALL/GERMANY
©MOREE



SENSO CINECAFE
BUCHAREST/ROMANIA
©ZERO ARCHITECTS



MOODIS LOUNGE BAR /
KORTRIJK, BELGIEN
©WWW.MOODIS.BE



BAR/GERMANY
©MOREE

Mehr Informationen online | Please read online | Plus d'informations en ligne
www.moree.de/en/projects/



MÖBEL - TECHNISCHE DATEN

FURNITURE TECHNICAL DATA | MEUBLES CARACTÉRISTIQUES TECHNIQUES

ED 45 | 75 | 105

ED WHITE/WHITE

Modell | Model | Modèle

18-04-45 | 75 | 105



DE	Material/ Farbe	Tischplatte: HPL weiß, sehr kratzsteife Oberfläche Mittelteil: Weiß pulverbeschichteter Stahl & Edelstahl gebürstet Bodenplatte: Edelstahl gebürstet
	Maße	L 60 x B 60 x H 45 75 105 cm
	Gewicht	12 13 14 kg
	Für Innenbereich	ja
	Für Aussenbereich	-

EN	Material/ Colour	Table Top: White HPL, very durable surface Column: White-powder-coated steel & brushed stainless steel Base: Brushed stainless steel
	Dimensions	L 60 x W 60 x H 45 75 105 cm
	Weight	12 13 14 kg
	For Indoor Use	yes
	For Outdoor Use	-

FR	Matériaux/ Couleur	Plateau de table: HPL blanc, surface très durable Colonne: Acier enduit de poudre blanche et acier inoxydable brossé Pied: Brossé Acier inoxydable
	Dimensions	Lo 60 x La 60 x H 45 75 105 cm
	Poids	12 13 14 kg
	Pour Utilisation Intérieure	oui
	Pour Utilisation Extérieure	-

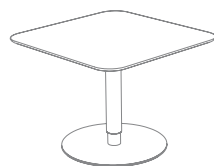

ED 45 | 600 x 600 x H450



ED 75 | 600 x 600 x H750

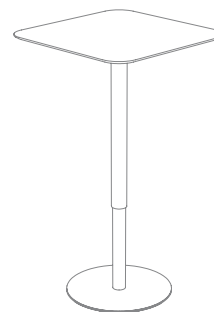

ED 105 | 600 x 600 x H1050

ED ADJUSTABLE WHITE & ANTHRACITE

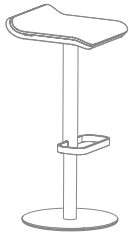

Weiß/
White/
Blanc



Anthrazit/
Anthracite/
Anthracite



Eiche/
Oak/
Chêne



Walnuss/
Walnut/
Noyer

Modell Model Modèle	ED WHITE/WHITE 13-02-03	ED WHITE/OAK 13-02-31
DE Material/Farbe	Sitzfläche: Formholz lackiert, weiß Sitz: Formholz lackiert, weiß Mittelteil: Stahl pulverbeschichtet weiß & Edelstahl gebürstet Fuss: Edelstahl gebürstet	Sitzfläche: Eiche Sitz: Formholz lackiert, weiß Mittelteil: Stahl pulverbeschichtet weiß & Edelstahl gebürstet Fuss: Edelstahl gebürstet
Individualisierung	Andere Farben auf Anfrage möglich	Andere Farben auf Anfrage möglich
Maße	L 38 x B 35 x H 81 cm max./min. H 81/55.5 cm	L 38 x B 35 x H 81 cm max./min. H 81/55.5 cm
Sitzhöhe	max./min. H 77/51.5 cm (stufenlos verstellbar)	max./min. H 77/51.5 cm (stufenlos verstellbar)
Gewicht	13 kg	13 kg
Für Innenbereich	ja	ja
Funktionen	<ul style="list-style-type: none"> • Höhenverstellbar • Im Sitz integrierter Stellhebel • 360 Rotation des Sitzes 	<ul style="list-style-type: none"> • Höhenverstellbar • Im Sitz integrierter Stellhebel • 360 Rotation des Sitzes
EN Material/Colour	Seat Top: Wood painted, white Seat: Wood painted, white Column: Powder-coated white steel & stainless steel Base: Brushed stainless steel	Seat Top: Oak Seat: Wood painted, white Column: Powder-coated white steel & stainless steel Base: Brushed stainless steel
Customisation	Other colours available on request	Other colours available on request
Dimensions	L 38 x W 35 x H 81 cm max./min. 81/55.5 cm	L 38 x W 35 x H 81 cm max./min. 81/55.5 cm
Seat Height	max./min. 77/51.5 cm (smooth height transition)	max./min. 77/51.5 cm (smooth height transition)
Weight	13 kg	13 kg
For Indoor Use	yes	yes
Functions	<ul style="list-style-type: none"> • Adjustable seat height • In seat integrated lever • 360 degree rotating seat 	<ul style="list-style-type: none"> • Adjustable seat height • In seat integrated lever • 360 degree rotating seat
FR Matériaux/Couleur	Surface de siège: Bois, laqué Siège: Bois, laqué Colonne: Acier blanc revêtement en poudre & acier inoxydable Pied: Acier inoxydable, brossé	Surface de siège: Chêne Siège: Bois, laqué Colonne: Acier blanc revêtement en poudre & acier inoxydable Pied: Acier inoxydable, brossé
Personnalisation	Autres couleurs disponibles sur demande	Autres couleurs disponibles sur demande
Dimensions	Lo 38 x La 35 x H 81 cm max./min. H 81/55.5 cm	Lo 38 x La 35 x H 81 cm max./min. H 81/55.5 cm
Hauteur du Siège	max./min. 77/51.5 cm (réglable en continu)	max./min. 77/51.5 cm (réglable en continu)
Poids	13 kg	13 kg
Pour Utilisation Intérieur	oui	oui
Fonctions	<ul style="list-style-type: none"> • La hauteur d'assise est réglable • Levier intégré dans le siège • Pivotant à 360 degrés 	<ul style="list-style-type: none"> • La hauteur d'assise est réglable • Levier intégré dans le siège • Pivotant à 360 degrés

ED WHITE/ WALNUT 13-02-32	ED ANTHRACITE/ WHITE 13-02-01	ED ANTHRACITE/ OAK 13-02-11	ED ANTHRACITE/ WALNUT 13-02-12
			
Sitzfläche: Walnuss Sitz: Formholz lackiert, weiß Mittelteil: Stahl pulverbeschichtet weiß & Edelstahl gebürstet Fuss: Edelstahl gebürstet	Sitzfläche: Formholz lackiert Sitz: Formholz lackiert, anthrazit Mittelteil: Stahl pulverbeschichtet Anthrazit/ Edelstahl gebürstet Fuss: Edelstahl gebürstet	Sitzfläche: Eiche Sitz: Formholz lackiert, anthrazit Mittelteil: Stahl pulverbeschichtet Anthrazit/ Edelstahl gebürstet Fuss: Edelstahl gebürstet	Sitzfläche: Walnuss Sitz: Formholz lackiert, anthrazit Mittelteil: Stahl pulverbeschichtet Anthrazit/ Edelstahl gebürstet Fuss: Edelstahl gebürstet
Andere Farben auf Anfrage möglich	Andere Farben auf Anfrage möglich	Andere Farben auf Anfrage möglich	Andere Farben auf Anfrage möglich
L 38 x B 35 x H 81 cm max./min. H 81/ 55.5 cm	L 38 x B 35 x H 81 cm max./min. H 81/ 55.5 cm	L 38 x B 35 x H 81 cm max./min. H 81/ 55.5 cm	L 38 x B 35 x H 81 cm max./min. H 81/ 55.5 cm
max./min. H 77/ 51.5 cm (stufenlos verstellbar)	max./min. H 77/ 51.5 cm (stufenlos verstellbar)	max./min. H 77/ 51.5 cm (stufenlos verstellbar)	max./min. H 77/ 51.5 cm (stufenlos verstellbar)
13 kg	13 kg	13 kg	13 kg
ja	ja	ja	ja
<ul style="list-style-type: none"> • Höhenverstellbar • Im Sitz integrierter Stellhebel • 360 Rotation des Sitzes 	<ul style="list-style-type: none"> • Höhenverstellbar • Im Sitz integrierter Stellhebel • 360 Rotation des Sitzes 	<ul style="list-style-type: none"> • Höhenverstellbar • Im Sitz integrierter Stellhebel • 360 Rotation des Sitzes 	<ul style="list-style-type: none"> • Höhenverstellbar • Im Sitz integrierter Stellhebel • 360 Rotation des Sitzes
Seat Top: Walnut Seat: Wood painted, white Column: Powder-coated steel & stainless steel Base: Brushed stainless steel	Seat Top: Wood painted, anthracite Seat: Wood painted, anthracite Column: Powder-coated anthracite steel & stainless steel Base: Brushed stainless steel	Seat Top: Oak Seat: Wood painted, anthracite Column: Powder-coated anthracite steel & stainless steel Base: Brushed stainless steel	Seat Top: Walnut Seat: Wood painted, anthracite Column: Powder-coated anthracite steel & stainless steel Base: Brushed stainless steel
Other colours available on request	Other colours available on request	Other colours available on request	Other colours available on request
L 38 x W 35 x H 81 cm max./min. 81/ 55.5 cm	L 38 x W 35 x H 81 cm max./min. 81/ 55.5 cm	L 38 x W 35 x H 81 cm max./min. 81/ 55.5 cm	L 38 x W 35 x H 81 cm max./min. 81/ 55.5 cm
max./min. 77/ 51.5 cm (smooth height transition)	max./min. 77/ 51.5 cm (smooth height transition)	max./min. 77/ 51.5 cm (smooth height transition)	max./min. 77/ 51.5 cm (smooth height transition)
13 kg	13 kg	13 kg	13 kg
yes	yes	yes	yes
<ul style="list-style-type: none"> • Adjustable seat height • In seat integrated lever • 360 degree rotating seat 	<ul style="list-style-type: none"> • Adjustable seat height • In seat integrated lever • 360 degree rotating seat 	<ul style="list-style-type: none"> • Adjustable seat height • In seat integrated lever • 360 degree rotating seat 	<ul style="list-style-type: none"> • Adjustable seat height • In seat integrated lever • 360 degree rotating seat
Surface de siège: Noyer Siège: Bois, laqué Colonne: Acier blanc revêtement en poudre & acier inoxydable Pied: Acier inoxydable, brossé	Surface de siège: Bois, laqué Siège: Bois, laqué Colonne: Acier anthrazit revêtement en poudre + acier inoxydable Pied: Acier inoxydable, brossé	Surface de siège: Chêne Siège: Bois, laqué Colonne: Acier anthrazit revêtement en poudre + acier inoxydable Pied: Acier inoxydable, brossé	Surface de siège: Noyer Siège: Bois, laqué Colonne: Acier anthrazit revêtement en poudre + acier inoxydable Pied: Acier inoxydable, brossé
Autres couleurs disponibles sur demande	Autres couleurs disponibles sur demande	Autres couleurs disponibles sur demande	Autres couleurs disponibles sur demande
Lo 38 x La 35 x H 81 cm max./min. H 81/ 55.5 cm	Lo 38 x La 35 x H 81 cm max./min. H 81/ 55.5 cm	Lo 38 x La 35 x H 81 cm max./min. H 81/ 55.5 cm	Lo 38 x La 35 x H 81 cm max./min. H 81/ 55.5 cm
max./min. 77/ 51.5 cm (réglable en continu)	max./min. 77/ 51.5 cm (réglable en continu)	max./min. 77/ 51.5 cm (réglable en continu)	max./min. 77/ 51.5 cm (réglable en continu)
13 kg	13 kg	13 kg	13 kg
oui	oui	oui	oui
<ul style="list-style-type: none"> • La hauteur d'assise est réglable • Levier intégré dans le siège • Pivotant à 360 degrés 	<ul style="list-style-type: none"> • La hauteur d'assise est réglable • Levier intégré dans le siège • Pivotant à 360 degrés 	<ul style="list-style-type: none"> • La hauteur d'assise est réglable • Levier intégré dans le siège • Pivotant à 360 degrés 	<ul style="list-style-type: none"> • La hauteur d'assise est réglable • Levier intégré dans le siège • Pivotant à 360 degrés

ED STATIC WHITE & ANTHRACITE

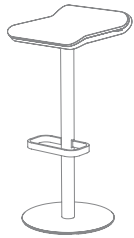

Weiß/
White/
Blanc



Anthrazit/
Anthracite/
Anthracite

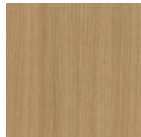

Eiche/
Oak/
Chêne

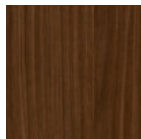

Walnuss/
Walnut/
Noyer

Modell Model Modèle	ED WHITE/ WHITE 13-01-03	ED WHITE/ OAK 13-01-31
DE Material/Farbe	Sitzfläche: Formholz lackiert, weiß Sitz: Formholz lackiert, weiß Mittelteil & Fuß: Stahl pulverbeschichtet weiß	Sitzfläche: Eiche Sitz: Formholz lackiert, weiß Mittelteil & Fuß: Stahl pulverbeschichtet weiß
Individualisierung	Andere Farben auf Anfrage möglich	Andere Farben auf Anfrage möglich
Maße	L 38 x B 35 x H 82.5 cm	L 38 x B 35 x H 82.5 cm
Sitzhöhe	H 78 cm (statisch)	H 78 cm (statisch)
Gewicht	11 kg	11 kg
Für Innenbereich	ja	ja
Funktionen	<ul style="list-style-type: none"> • Mehrere Sitzdesigns erhältlich • Barhockersitz Dave auch montierbar 	<ul style="list-style-type: none"> • Mehrere Sitzdesigns erhältlich • Barhockersitz Dave auch montierbar
EN Material/Colour	Seat Top: Wood painted, white Seat: Wood painted, white Column & Base: Powder-coated white	Seat Top: Oak Seat: Wood painted, white Column & Base: Powder-coated white
Customisation	Other colours available on request	Other colours available on request
Dimensions	L 38 x W 35 x H 82.5 cm	L 38 x W 35 x H 82.5 cm
Seat Height	H 78 cm (static)	H 78 cm (static)
Weight	11 kg	11 kg
For Indoor Use	yes	yes
Functions	<ul style="list-style-type: none"> • Several seat designs available • Barstool seat Dave also mountable 	<ul style="list-style-type: none"> • Several seat designs available • Barstool seat Dave also mountable
FR Matériaux/ Couleur	Surface de siège: Bois, laqué Siège: Bois, laqué Colonne & Pied: Acier blanc revêtement en poudre	Surface de siège: Bois, laqué Siège: Bois, laqué Colonne & Pied: Acier blanc revêtement en poudre
Personnalisation	Autres couleurs disponibles sur demande	Autres couleurs disponibles sur demande
Dimensions	Lo 38 x La 35 x H 82.5 cm	Lo 38 x La 35 x H 82.5 cm
Hauteur du Siège	H 78 cm (statique)	H 78 cm (statique)
Poids	11 kg	11 kg
Pour Utilisation Intérieur	oui	oui
Fonctions	<ul style="list-style-type: none"> • Plusieurs designs de sièges disponibles • Siège de tabouret de bar Dave également montable 	<ul style="list-style-type: none"> • Plusieurs designs de sièges disponibles • Siège de tabouret de bar Dave également montable

ED WHITE/ WALNUT

13-01-32



Sitzfläche: Walnuss
Sitz: Formholz lackiert, weiß
Mittelteil & Fuß:
Stahl pulverbeschichtet weiß

Andere Farben auf Anfrage möglich

L 38 x B 35 x H 82.5 cm

H 78 cm (statisch)

11 kg

ja

- Mehrere Sitzdesigns erhältlich
- Barhockersitz Dave auch montierbar

ED ANTHRACITE/ WHITE

13-01-01



Sitzfläche: Formholz lackiert
Sitz: Formholz lackiert, anthrazit
Mittelteil & Fuß:
Stahl pulverbeschichtet Anthrazit

Andere Farben auf Anfrage möglich

L 38 x B 35 x H 82.5 cm

H 78 cm (statisch)

11 kg

ja

- Mehrere Sitzdesigns erhältlich
- Barhockersitz Dave auch montierbar

ED ANTHRACITE/ OAK

13-01-11



Sitzfläche: Eiche
Sitz: Formholz lackiert, anthrazit
Mittelteil & Fuß:
Stahl pulverbeschichtet Anthrazit

Andere Farben auf Anfrage möglich

L 38 x B 35 x H 82.5 cm

H 78 cm (statisch)

11 kg

ja

- Mehrere Sitzdesigns erhältlich
- Barhockersitz Dave auch montierbar

ED ANTHRACITE/ WALNUT

13-01-12



Sitzfläche: Walnuss
Sitz: Formholz lackiert, anthrazit
Mittelteil & Fuß:
Stahl pulverbeschichtet Anthrazit

Andere Farben auf Anfrage möglich

L 38 x B 35 x H 82.5 cm

H 78 cm (statisch)

11 kg

ja

- Mehrere Sitzdesigns erhältlich
- Barhockersitz Dave auch montierbar

Seat Top: Walnut
Seat: Wood painted, white
Column & Base: Powder-coated white

Other colours available on request

L 38 x W 35 x H 82.5 cm

H 78 cm (static)

11 kg

yes

- Several seat designs available
- Barstool seat Dave also mountable

Seat Top: Wood painted, anthracite
Seat: Wood painted, anthracite
Column & Base:
Powder-coated anthracite

Other colours available on request

L 38 x W 35 x H 82.5 cm

H 78 cm (static)

11 kg

yes

- Several seat designs available
- Barstool seat Dave also mountable

Seat Top: Oak
Seat: Wood painted, anthracite
Column & Base:
Powder-coated anthracite

Other colours available on request

L 38 x W 35 x H 82.5 cm

H 78 cm (static)

11 kg

yes

- Several seat designs available
- Barstool seat Dave also mountable

Seat Top: Walnut
Seat: Wood painted, anthracite
Column & Base:
Powder-coated anthracite

Other colours available on request

L 38 x W 35 x H 82.5 cm

H 78 cm (static)

11 kg

yes

- Several seat designs available
- Barstool seat Dave also mountable

Surface de siège: Noyer
Siège: Bois, laqué
Colonne & Pied:
Acier blanc revêtement en poudre

Autres couleurs disponibles sur demande

Lo 38 x La 35 x H 82.5 cm

H 78 cm (statique)

11 kg

oui

- Plusieurs designs de sièges disponibles
- Siège de tabouret de bar Dave également montable

Surface de siège: Bois, laqué
Siège: Bois, laqué
Colonne & Pied:
Acier anthrazit revêtement en poudre

Autres couleurs disponibles sur demande

Lo 38 x La 35 x H 82.5 cm

H 78 cm (statique)

11 kg

oui

- Plusieurs designs de sièges disponibles
- Siège de tabouret de bar Dave également montable

Surface de siège: Chêne
Siège: Bois, laqué
Colonne & Pied:
Acier anthrazit revêtement en poudre

Autres couleurs disponibles sur demande

Lo 38 x La 35 x H 82.5 cm

H 78 cm (statique)

11 kg

oui

- Plusieurs designs de sièges disponibles
- Siège de tabouret de bar Dave également montable

Surface de siège: Noyer
Siège: Bois, laqué
Colonne & Pied:
Acier anthrazit revêtement en poudre

Autres couleurs disponibles sur demande

Lo 38 x La 35 x H 82.5 cm

H 78 cm (statique)

11 kg

oui

- Plusieurs designs de sièges disponibles
- Siège de tabouret de bar Dave également montable

DAVE WHITE DAVE ANTHRACITE

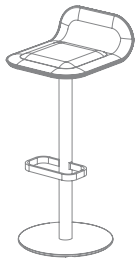

Stoffbezug aus 98%
recyceltem Material
Fabric cover made from
98% recycled material
Housse en tissu à 98% de
matières recyclées

	DAVE WHITE 42-01-0X	DAVE ANTHRACITE 42-02-0X
DE Material/Farbe (Gestell)	Mittelteil: Stahl pulverbeschichtet Bodenplatte: Stahl pulverbeschichtet/ Weiß matt (ähnlich RAL 9016)	Mittelteil: Stahl pulverbeschichtet Bodenplatte: Stahl pulverbeschichtet/ Anthrakit, matt (ähnlich RAL 7012)
Farbe (Sitz)	42-01-01 DAVE Weiß/Sitz Hellgrau 42-01-02 DAVE Weiß/Sitz Anthrazit 42-01-03 DAVE Weiß/Sitz Salbei 42-01-04 DAVE Weiß/Sitz Weinrot	42-02-01 DAVE Weiß/Sitz Hellgrau 42-02-02 DAVE Weiß/Sitz Anthrazit 42-02-03 DAVE Weiß/Sitz Salbei 42-02-04 DAVE Weiß/Sitz Weinrot
Material (Sitz): Formholz, gepolstert	<ul style="list-style-type: none"> • Stoffbezug: Polyester 98% recycled, 2% PE • Abrieb: Martindale 100.000 • Pilling: 4-5 • Lichtechtheitsskala: 5-8 • Reibechtheitsskala: (nass/trocken) 4-5/4-5 • Entflammbarkeit: BS EN 1021 1 & 2 • CA TB 117-2013/ASTM E 84 Klasse I • Umwelt Label: STANDARD 100 	<ul style="list-style-type: none"> • Stoffbezug: Polyester 98% recycled, 2% PE • Abrieb: Martindale 100.000 • Pilling: 4-5 • Lichtechtheitsskala: 5-8 • Reibechtheitsskala: (nass/trocken) 4-5/4-5 • Entflammbarkeit: BS EN 1021 1 & 2 • CA TB 117-2013/ASTM E 84 Klasse I • Umwelt Label: STANDARD 100
Maße/Sitzhöhe	T 41 x B 37 x H 90 cm/H 78 cm	T 41 x B 37 x H 90 cm/78 cm
Maße Sitz	T 41 x B 37 x H 12 cm	T 41 x B 37 x H 12 cm
Gewicht	10 kg	10 kg
Für Innenbereich	Home & Contract	Home & Contract
EN Material/Colour (Stand)	Middle part: Steel, Powder-coated Base: Steel, Powder-coated White matte (similar RAL 9016)	Middle part: Steel, Powder-coated Base: Steel, Powder-coated Anthracite matte (similar RAL 7012)
Colour (Seat)	42-01-01 DAVE White/Seat Light Grey 42-01-02 DAVE White/Seat Anthracite 42-01-03 DAVE White/Seat Sage 42-01-04 DAVE White/Seat Wine Red	42-02-01 DAVE Anthracite/Seat Light Grey 42-02-02 DAVE Anthracite/Seat Anthracite 42-02-03 DAVE Anthracite/Seat Sage 42-02-04 DAVE Anthracite/Seat Wine Red
Material (Seat): Molded wood, upholstered	<ul style="list-style-type: none"> • Polyester fabric 98% recycled, 2% PE • Abrasion: Rubs martindale 100,000 • Pilling: 4-5 • Light fastness: 5-8 • Rubbing fastness: (wet/dry)/4-5/4-5 • Flammability: BS EN 1021 1&2 • CA TB 117-2013/ASTM E 84 Class I • Environment: STANDARD 100 	<ul style="list-style-type: none"> • Polyester fabric 98% recycled, 2% PE • Abrasion: Rubs martindale 100,000 • Pilling: 4-5 • Light fastness: 5-8 • Rubbing fastness: (wet/dry)/4-5/4-5 • Flammability: BS EN 1021 1&2 • CA TB 117-2013/ASTM E 84 Class I • Environment: STANDARD 100
Dimensions/Seat Height	D 41 x W 37 x H 90 cm/H 78 cm	D 41 x W 37 x H 90 cm/H 78 cm
Dimensions/Seat	D 41 x W 37 x H 12 cm	D 41 x W 37 x H 12 cm
Weight	10 kg	10 kg
For Indoor Use	Home & Contract	Home & Contract
FR Matériaux/Couleur	Colonne: Acier, Revêtement en poudre Plaque d'assise: Acier, Revêtement en poudre/Blanc mat (similaire RAL 9016)	Colonne: Acier, Revêtement en poudre Plaque d'assise: Acier, Revêtement en poudre/Blanc mat (similaire RAL 7012)
Couleur Siège	42-01-01 DAVE Blanc/Gris Clair 42-01-02 DAVE Blanc/Anthracite 42-01-03 DAVE Blanc/Sauge 42-01-04 DAVE Blanc/Lie de Vin	42-02-01 DAVE Anthracite/Gris Clair 42-02-02 DAVE Anthracite/Anthracite 42-02-03 DAVE Anthracite/Sauge 42-02-04 DAVE Anthracite/Lie de Vin
Matériaux Siège: Bois Moulé, Rembourré	<ul style="list-style-type: none"> • Tissu Polyester 98% recyclé, 2% PE • Abrasion: Testé Martindale 100,000 • Pilling: 4-5 • Solidité lumière: 5-8 • Solidité frottement: (mouillé/sec) 4-5/4-5 • Inflammabilité: BS EN 1021 1&2 • CA TB 117-2013/ASTM E 84 Classe I • Environnement: STANDARD 100 	<ul style="list-style-type: none"> • Tissu Polyester 98% recyclé, 2% PE • Abrasion: Testé Martindale 100,000 • Pilling: 4-5 • Solidité lumière: 5-8 • Solidité frottement: (mouillé/sec) 4-5/4-5 • Inflammabilité: BS EN 1021 1&2 • CA TB 117-2013/ASTM E 84 Classe I • Environnement: STANDARD 100
Dimensions/Hauteur d'assise	L 41 x L 37 x H 90 cm/H 78 cm	L 41 x L 37 x H 90 cm/H 78 cm
Dimensions Siège	L 41 x L 37 x H 12 cm	L 41 x L 37 x H 12 cm
Poids	10 kg	10 kg
Pour Utilisation Intérieur	Maison & Collectivité	Maison & Collectivité

DAVE SEAT

Standard-Farben
Standard Colors
Couleurs standards

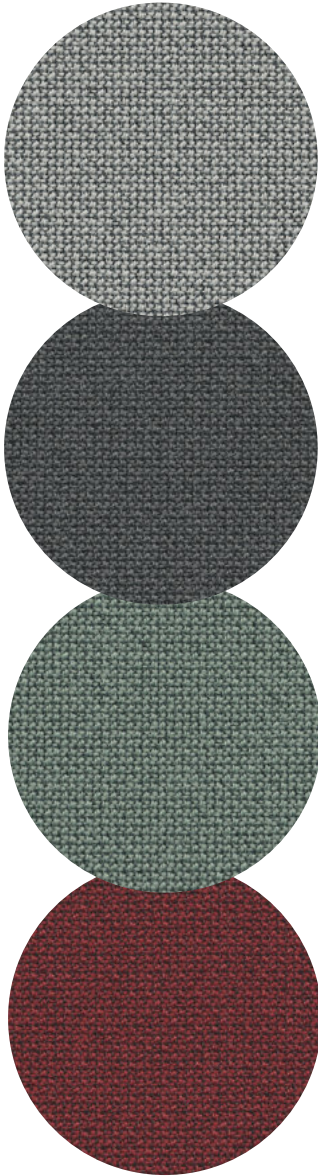

Hellgrau/
Light Grey/
Gris clair

Anthrazit/
Anthracite/
Anthracite

Salbei/
Sage/
Sauge

Weinrot/
Wine Red/
Lie de Vin

DAVE SEAT

Weitere Farben auf Anfrage lieferbar.
Other colors available on request.
D'autres couleurs disponibles sur demande.

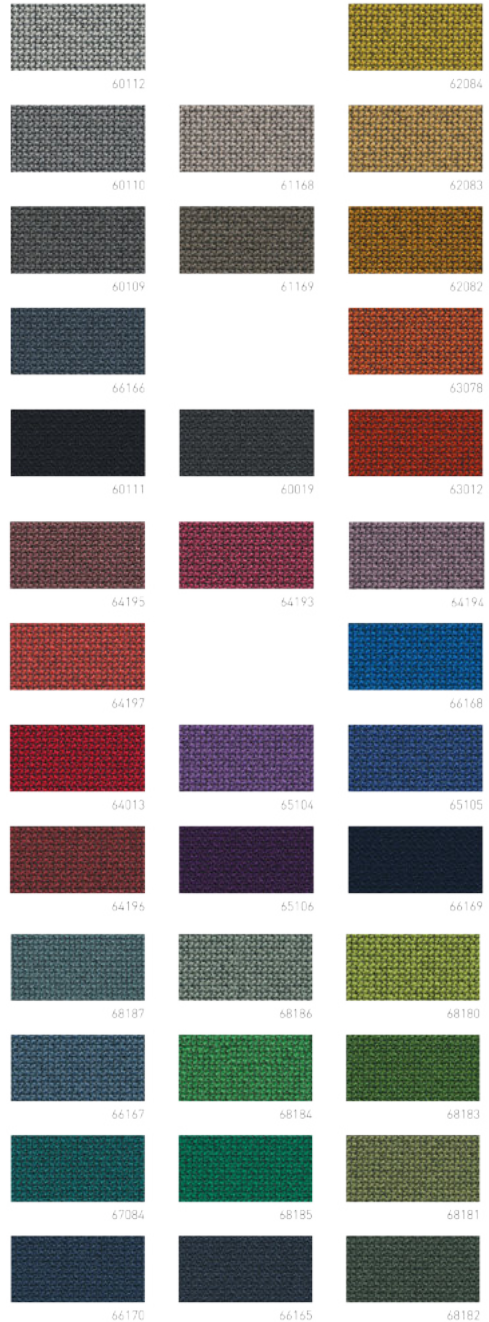

AIR BAR & AIR BUFFET

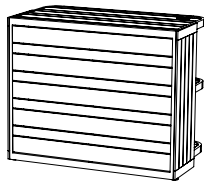
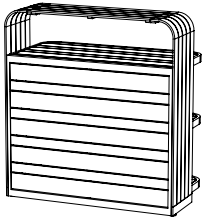

WHITE



ANTHRACITE







ANTHRACITE/
WOOD (POLYSTYRENE)

Modell Model Modèle	OUTDOOR BAR WHITE MOD. 45-01-01	OUTDOOR BAR ANTHRACITE MOD. 45-02-01
DE Material/Farbe	Aluminium pulverbeschichtet/ Weiß (ähnlich RAL 9003 Signalweiß)	Aluminium pulverbeschichtet/ Anthrazit (ähnlich RAL 7012 Basalt- grau)
Individualisierung	Auf Anfrage	Auf Anfrage
Maße	L 110 x B 57 x H 110 cm	L 110 x B 57 x H 110 cm
Arbeitsflächenhöhe	85 cm	85 cm
Gewicht	35 kg	35 kg
Für Aussenbereich	Ja	Ja
Funktionen	<ul style="list-style-type: none"> • Sonnenschirmhalterung • Halterung für zusätzliche Gewichte 	<ul style="list-style-type: none"> • Sonnenschirmhalterung • Halterung für zusätzliche Gewichte
EN Material/Colour	Aluminium powder coated/ White (similar to RAL 9003 signal white)	Aluminium powder coated/ Anthracite (similar to RAL 7012 basalt grey)
Customisation	On Request	On Request
Dimensions	L 110 x W 57 x H 110 cm	L 110 x W 57 x H 110 cm
Worktop Height	85 cm	85 cm
Weight	35 kg	35 kg
For Outdoor Use	Yes	Yes
Functions	<ul style="list-style-type: none"> • Parasol Holder • Holder for additional weights 	<ul style="list-style-type: none"> • Parasol Holder • Holder for additional weights
FR Matériaux/Couleur	Aluminium revêtu par poudre/ Blanc (similaire à RAL 9003 blanc de sécurité)	Aluminium revêtu par poudre/ Anthracite (similaire à RAL 7012 gris basalte)
Personnalisation	Sur demande	Sur demande
Dimensions	Lo 110 x La 57 x H 110 cm	Lo 110 x La 57 x H 110 cm
Hauteur du plan de travail	85 cm	85 cm
Poids	35 kg	35 kg
Pour les espaces extérieurs	Oui	Oui
Fonctions	<ul style="list-style-type: none"> • Support pour parasol • Support pour des poids supplémentaires 	<ul style="list-style-type: none"> • Support pour parasol • Support pour des poids supplémentaires

Mehr Informationen online
More information can be found online
Plus d'informations en ligne

www.moree.de

OUTDOOR BAR ANTHRACITE/WOOD MOD. 45-03-01	OUTDOOR BUFFET WHITE/ WHITE MOD. 45-01-02	OUTDOOR BUFFET ANTHRACITE MOD. 45-02-02	OUT BUFFET ANTHRACITE/WOOD MOD. 45-03-02
			
Aluminium pulverbeschichtet/ Anthrazit (ähnlich RAL 7012 Basalt- grau), Front aus Holz (Polystyrene)	Aluminium pulverbeschichtet/ Weiß (ähnlich RAL 9003 Signalweiß)	Aluminium pulverbeschichtet/ Anthrazit (ähnlich RAL 7012 Basalt- grau)	Aluminium pulverbeschichtet/ Anthrazit (ähnlich RAL 7012 Basalt- grau), Front aus Holz (Polystyrene)
Auf Anfrage	Auf Anfrage	Auf Anfrage	Auf Anfrage
L 110 x B 57 x H 110 cm	L 110 x B 57 x H 85 cm	L 110 x B 57 x H 85 cm	L 110 x B 57 x H 85 cm
85 cm	85 cm	85 cm	85 cm
35 kg	32 kg	32 kg	32 kg
Ja	Ja	Ja	Ja
<ul style="list-style-type: none"> • Sonnenschirmhalterung • Halterung für zusätzliche Gewichte 	<ul style="list-style-type: none"> • Sonnenschirmhalterung • Halterung für zusätzliche Gewichte 	<ul style="list-style-type: none"> • Sonnenschirmhalterung • Halterung für zusätzliche Gewichte 	<ul style="list-style-type: none"> • Sonnenschirmhalterung • Halterung für zusätzliche Gewichte
Aluminium powder coated/ Anthracite (similar to RAL 7012 basalt grey), Front in wood (Polystyrene)	Aluminium powder coated/ White (similar to RAL 9003 signal white)	Aluminium powder coated/ Anthracite (similar to RAL 7012 basalt grey)	Aluminium powder coated/ Anthracite (similar to RAL 7012 basalt grey), Front in wood (Polystyrene)
On Request	On Request	On Request	On Request
L 110 x W 57 x H 110 cm	L 110 x W 57 x H 85 cm	L 110 x W 57 x H 85 cm	L 110 x W 57 x H 85 cm
85 cm	85 cm	85 cm	85 cm
35 kg	32 kg	32 kg	32 kg
Yes	Yes	Yes	Yes
<ul style="list-style-type: none"> • Parasol Holder • Holder for additional weights 	<ul style="list-style-type: none"> • Parasol Holder • Holder for additional weights 	<ul style="list-style-type: none"> • Parasol Holder • Holder for additional weights 	<ul style="list-style-type: none"> • Parasol Holder • Holder for additional weights
Aluminium revêtu par poudre/ Anthracite (similaire à RAL 7012 gris basalte), Face avant en bois (Polystyrène)	Aluminium revêtu par poudre/ Blanc (similaire à RAL 9003 blanc de sécurité)	Aluminium revêtu par poudre/ Anthracite (similaire à RAL 7012 gris basalte)	Aluminium revêtu par poudre/ Anthracite (similaire à RAL 7012 gris basalte), Face avant en bois (Polystyrène)
Sur demande	Sur demande	Sur demande	Sur demande
Lo 110 x La 57 x H 110 cm	Lo 110 x La 57 x H 85 cm	Lo 110 x La 57 x H 85 cm	Lo 110 x La 57 x H 85 cm
85 cm	85 cm	85 cm	85 cm
35 kg	32 kg	32 kg	32 kg
Oui	Oui	Oui	Oui
<ul style="list-style-type: none"> • Support pour parasol • Support pour des poids supplémentaires 	<ul style="list-style-type: none"> • Support pour parasol • Support pour des poids supplémentaires 	<ul style="list-style-type: none"> • Support pour parasol • Support pour des poids supplémentaires 	<ul style="list-style-type: none"> • Support pour parasol • Support pour des poids supplémentaires

AIR BARSTOOL

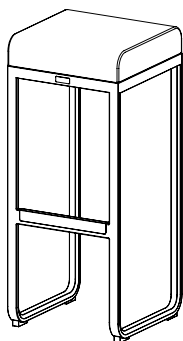

WHITE



ANTHRACITE

Modell Model Modèle	OUTDOOR BARSTOOL WHITE MOD. 45-01-03	OUTDOOR BARSTOOL ANTHRACITE MOD. 45-02-03
DE Material /Farbe	Sitz: Polyester/Grau Gestell: Aluminium pulverbeschichtet/ Weiß (ähnlich RAL 9003 Signalweiß)	Sitz: Polyester/Grau Gestell: Aluminium pulverbeschichtet/ Anthrazit (ähnlich RAL 7012 Basaltgrau)
Individualisierung	Auf Anfrage	Auf Anfrage
Maße	L 36 x B 36 x H 80 cm	L 36 x B 36 x H 80 cm
Sitzhöhe	80 cm	80 cm
Gewicht	3,6 kg	3,6 kg
Für Aussenbereich	Ja	Ja
EN Material/Colour	Seat: Polyester/Grey Frame: powder-coated aluminium/ White (similar to RAL 9003 signal white)	Seat: Polyester/Grey Frame: powder-coated aluminium/ Anthracite (similar to RAL 7012 basalt grey)
Customisation	On Request	On Request
Dimensions	L 36 x W 36 x H 80 cm	L 36 x W 36 x H 80 cm
Seat Height	80 cm	80 cm
Weight	3,6 kg	3,6 kg
For Outdoor Use	Yes	Yes
FR Matériaux/Couleur	Siège: Polyester/Gris Structure: Aluminium peint par poudrage/ Blanc (similaire à RAL 9003)	Siège: Polyester/Gris Structure: Aluminium peint par poudrage/ Anthracite (similaire à RAL 7012)
Personnalisation	Sur demande	Sur demande
Dimensions	Lo 36 x La 36 x H 80 cm	Lo 36 x La 36 x H 80 cm
Hauteur du plan de travail	80 cm	80 cm
Poids	3,6 kg	3,6 kg
Pour les espaces extérieurs	Oui	Oui

AIR PARASOL

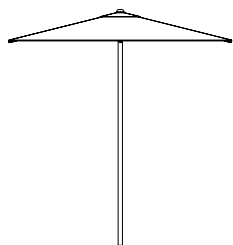

PARASOL
WHITE/LIGHT GREY
MOD. 45-01-04

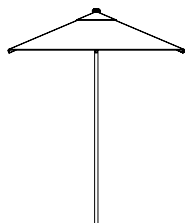

PARASOL
ANTHRACITE/
WOOD
MOD. 45-02-04

Modell Model Modèle	PARASOL WHITE/ALUMINIUM MOD. 45-01-04	PARASOL ANTHRACITE/WOOD MOD. 45-02-04
DE Material/Farbe	Stoffbezug: Olefin 190 gr/ Weiß Gestell: Aluminium/Hellgrau	Stoffbezug: Olefin 190 gr/ Anthrazit Gestell: FSC-zertifiziertes lackiertes Eukalyptusholz
Gestell	Mit 8 Rippen	Mit 8 Rippen
Maße	L 250 x B 250 x H 270 cm	L 200 x B 200 x H 250 cm
Durchgangshöhe	230 cm	200 cm
Gewicht	8 kg	9 kg
Für Aussenbereich	Ja	Ja
Funktionen	<ul style="list-style-type: none"> • Riemen Öffnungssystem • Mit Entlüftung 	<ul style="list-style-type: none"> • Riemen Öffnungssystem • Mit Entlüftung
EN Material/Colour	Fabric cover: Olefin 190 gr/ White Frame: Aluminium/Light grey	Fabric cover: Olefin 190 gr/anthracite Frame: FSC-certified lacquered eucalyptus wood
Frame	8 ribs	8 ribs
Dimensions	L 250 x W 250 x H 270 cm	L 200 x W 200 x H 250 cm
Headroom	230 cm	200 cm
Weight	8 kg	9 kg
For Outdoor Use	Yes	Yes
Functions	<ul style="list-style-type: none"> • Parasol Holder • Holder for additional weights 	<ul style="list-style-type: none"> • Pulley opening system • With airvent
FR Matériaux/Couleur	Housse en tissu: Oléfine 190 gr/ Blanc Châssis: Aluminium/Gris clair	Housse en tissu: Oléfine 190 gr/ Anthracite Châssis: Verni, certifié FSC bois d'eucalyptus
Structure	Avec 8 bras	Avec 8 bras
Dimensions	Lo 250 x La 250 x H 270 cm	Lo 200 x La 200 x H 250 cm
Hauteur de passage	230 cm	200 cm
Poids	8 kg	9 kg
Pour les espaces extérieurs	Oui	Oui
Fonctions	<ul style="list-style-type: none"> • Système d'ouverture de la courroie • Avec aération 	<ul style="list-style-type: none"> • Système d'ouverture de la courroie • Avec aération

1M COUNTER

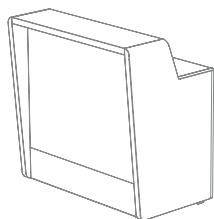

Andere Farben & Materialien
auf Anfrage möglich.
Other colours & Materials
available on request.
Autres couleurs et matériaux
disponibles sur demande.

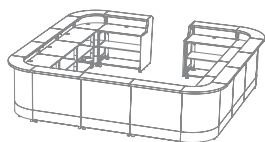

	1M COUNTER RADIUS	1M COUNTER EDGE
Modell Model Modèle	19-02-09	19-02-10
DE		
Material	Holz, beschichtet	Holz, beschichtet
Material Endstück	Holz, lackiert	Holz, beschichtet
Farbe	Weiß, seidenmatt	Weiß, seidenmatt
Maße	L700 x B1080 x H1060 mm	L700 x B1080 x H1060 mm
Gewicht	ca. 54 kg	ca. 54 kg
Energieeffizienz-Klasse	G	G
Front- & Arbeitsplatz-Beleuchtung	Eingebaute LED-Einheit (ausbaubar) 2x 10 W, 2x 370 lm	Eingebaute LED-Einheit (ausbaubar) 2x 10 W, 2x 370 lm
Fernbedienung	Funk	Funk
Ladegerät	-	-
Verkabelung	ca. 4 m, schwarz	ca. 4 m, schwarz
Spannung	200-240 VAC, 50 Hz	200-240 VAC, 50 Hz
Schutzklasse	II	II
Für Innenbereich	Ja	Ja
EN		
Material	Wood, laminated	Wood, laminated
Material Endcaps	Wood, spray painted	Wood, laminated
Colour	Satin white	Satin white
Dimensions	L700 x W1080 x H106 mm	L700 x W1080 x H1060 mm
Weight	approx. 54 kg	approx. 54 kg
Energy Class	G	G
Illuminant front/ workspace	Built-In LED Unit (removable) 2x 10 W, 2x 370 lm	Built-In LED Unit (removable) 2x 10 W, 2x 370 lm
Remote Control	Radio	Radio
Charger	-	-
Cable	approx. 4 m, black	approx. 4 m, black
Voltage	200-240 VAC, 50 Hz	200-240 VAC, 50 Hz
Protection Class	II	II
For Indoor Use	Yes	Yes
FR		
Matériaux	Bois, revêtement	Bois, revêtement
Matériaux Embouts	Bois, laqué	Bois, revêtement
Couleur	Blanc satiné	Blanc satiné
Dimensions	Lo 700 x La 1080 x H1060 mm	Lo 700 x La 1080 x H1060 mm
Poids	env. 54 kg	env. 54 kg
Classe Énergétique	G	G
Lumière led avant/ espace de travail	Unité à LED intégrée (amovible) 2x 10 W, 2x 370 lm	Unité à LED intégrée (amovible) 2x 10 W, 2x 370 lm
Télécommande	Radio contrôle	Radio contrôle
Chargeur	-	-
Câblage	env. 4 m, Noir	env. 4 m, noir
Tension	200-240 VAC, 50 Hz	200-240 VAC, 50 Hz
Catégorie	II	II
Pour Utilisation Intérieur	Oui	Oui

Mehr Informationen im Thekenkatalog online
Please read our bar catalogue online
Plus d'informations dans le catalogue en ligne
www.moree.de

60° COUNTER

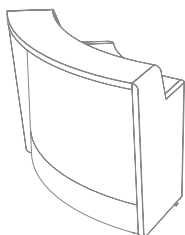

Andere Farben & Materialien auf Anfrage möglich.
Other colours & Materials available on request.
Autres couleurs et matériaux disponibles sur demande.

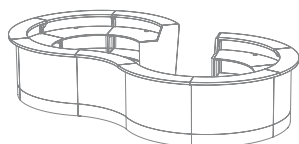

Modell Model Modèle	60° COUNTER RADIUS 19-02-11	60° COUNTER EDGE 19-02-12
DE	<p>Material Holz, beschichtet</p> <p>Material Endstück Holz, lackiert</p> <p>Farbe Weiß, seidenmatt</p> <p>Maße L700 x B1515 x H1060 mm</p> <p>Gewicht ca. 62 kg</p> <p>Energieeffizienz-Klasse G</p> <p>Front- & Arbeitsplatz-Beleuchtung Eingebaute LED-Einheit (ausbaubar) 15 W, 560 lm/ 14 W, 500 lm</p> <p>Fernbedienung Funk</p> <p>Ladegerät -</p> <p>Verkabelung ca. 4 m, schwarz</p> <p>Spannung 200-240 VAC, 50 Hz</p> <p>Schutzklasse II</p> <p>Für Innenbereich Ja</p>	<p>Material Holz, beschichtet</p> <p>Material Endstück Holz, beschichtet</p> <p>Farbe Weiß, seidenmatt</p> <p>Maße L700 x B1520 x H1060 mm</p> <p>Gewicht ca. 62 kg</p> <p>Energieeffizienz-Klasse G</p> <p>Front- & Arbeitsplatz-Beleuchtung Eingebaute LED-Einheit (ausbaubar) 15 W, 560 lm/ 14 W, 500 lm</p> <p>Fernbedienung Funk</p> <p>Ladegerät -</p> <p>Verkabelung ca. 4 m, schwarz</p> <p>Spannung 200-240 VAC, 50 Hz</p> <p>Schutzklasse II</p> <p>Für Innenbereich Ja</p>
EN	<p>Material Wood, laminated</p> <p>Material Endcaps Wood, spray painted</p> <p>Colour Satin white</p> <p>Dimensions L700 x W1515 x H1060 mm</p> <p>Weight approx. 62 kg</p> <p>Energy Class G</p> <p>Illuminant front/ workspace Built-In LED Unit (removable) 15 W, 560 lm/ 14 W, 500 lm</p> <p>Remote Control Radio</p> <p>Charger -</p> <p>Cable approx. 4 m, Black</p> <p>Voltage 200-240 VAC, 50 Hz</p> <p>Protection Class II</p> <p>For Indoor Use Yes</p>	<p>Material Wood, laminated</p> <p>Material Endcaps Wood, laminated</p> <p>Colour Satin white</p> <p>Dimensions L700 x W1520 x H1060 mm</p> <p>Weight approx. 62 kg</p> <p>Energy Class G</p> <p>Illuminant front/ workspace Built-In LED Unit (removable) 15 W, 560 lm/ 14 W, 500 lm</p> <p>Remote Control Radio</p> <p>Charger -</p> <p>Cable approx. 4 m, Black</p> <p>Voltage 200-240 VAC, 50 Hz</p> <p>Protection Class II</p> <p>For Indoor Use Yes</p>
FR	<p>Matériaux Bois, revêtement</p> <p>Matériaux Embouts Bois, laqué</p> <p>Coleur Blanc satiné</p> <p>Dimensions Lo 700 x La 1515 x H1060 mm</p> <p>Poids env. 62 kg</p> <p>Classe Énergétique G</p> <p>Lumière led avant/ espace de travail Unité à LED intégrée (amovible) 15 W, 560 lm/ 14 W, 500 lm</p> <p>Télécommande Radio contrôle</p> <p>Chargeur -</p> <p>Câblage env. 4 m, noir</p> <p>Tension 200-240 VAC, 50 Hz</p> <p>Catégorie II</p> <p>Pour Utilisation Intérieur Oui</p>	<p>Bois, revêtement</p> <p>Bois, revêtement</p> <p>Blanc satiné</p> <p>Lo 700 x La 1520 x H1060 mm</p> <p>env. 62 kg</p> <p>G</p> <p>Unité à LED intégrée (amovible) 15 W, 560 lm/ 14 W, 500 lm</p> <p>Radio contrôle</p> <p>-</p> <p>env. 4 m, noir</p> <p>200-240 VAC, 50 Hz</p> <p>II</p> <p>Oui</p>

Mehr Informationen im Thekenkatalog online
Please read our bar catalogue online
Plus d'informations dans le catalogue en ligne

www.moree.de

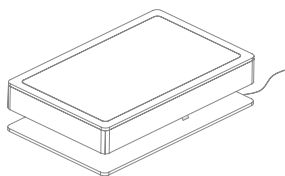

Inklusive: 5 mm Glasplatte
Including: 5 mm glass top
Inclus: 5 mm tablette en verre

Modell | Model | Modèle

ORA HOME X

28-17-01



ORA HOME LED PRO

28-16-01



DE	Material	Holz, lackiert	MDF, lackiert
	Farbe	Weiß seidenmatt	Weiß, seidenmatt
	Maße	L 1100 x B 700 x H 290 mm	L 1100 x B 700 x H 290 mm
	Gewicht	ca. 26.3 kg	ca. 28.2 kg
	Lampenfassung	-	Eingebaute LED-Einheit (ausbaubar)
	Leuchtmittel	-	Multicolor LEDs, max 29 W, EEC: G, max. 1500 lm, Lebensdauer: 30000 h Warmweißes Licht 2700 K
	Fernbedienung	-	Funk
	Aufladbarer Akku/ Ladezeit Laufzeit (in Farbwechsel)	-	-
	Ladegerät	-	-
	Verkabelung	-	ca. 3 m, rot
	Spannung	-	200-240 VAC, 50 Hz
	Schutzklasse	-	II
	Für Innenbereich	Ja	Ja

EN	Material	Wood, spray painted	Wood, spray painted
	Colour	White, satin	White, satin
	Dimensions	L 1100 x W 700 x H 290 mm	L 1100 x W 700 x H 290 mm
	Weight	approx. 26.3 kg	approx. 28.2 kg
	Lamp Holder	-	Built-In LED Unit (removable)
	Illuminant	-	Multicolor LEDs, max 29 W, EEC: G, max. 1500 lm, life span: 30000 h Warm white light 2700 K
	Remote Control	-	Radio
	Recharable battery/ ChargingTime Runtime (in colour change)	-	-
	Charger	-	-
	Cable	-	approx. 3 m, red
	Voltage	-	200-240 VAC, 50 Hz
	Protection Class	-	II
	For Indoor Use	Yes	Yes

FR	Matériaux	Bois, laqué	Bois, laqué
	Couleur	Blanc satin	Blanc satin
	Dimensions	Lo 1100 x La 700 x H 290 mm	Lo 1100 x La 700 x H 290 mm
	Poids	env. 26.3 kg	env. 28.2 kg
	Support de Lampe	-	Unité à LED intégrée (amovible)
	Ampoule	-	LED multicolore, max 29 W, CÉ: F, max. 1500 lm, durée de vie: 30000 h Lumière blanc chaud 2700K
	Télécommande	-	Radio contrôle
	Batterie/ Temps de Charge Autonomie (en changement de couleur)	-	-
	Chargeur	-	-
	Câblage	-	env. 3 m, rouge
	Tension	-	200-240 VAC, 50 Hz
	Catégorie	-	II
	Pour utilisation intérieur	Oui	Oui

LOUNGE

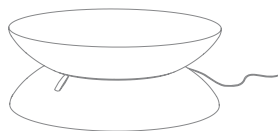

Inklusive: 5 mm Glasplatte
Including: 5 mm glass top
Inclus: 5 mm tablette en verre

LOUNGE INDOOR

LOUNGE INDOOR LED

Modell Model Modèle	04-05-01	04-05-01-LED
	  	    
Maße Dimensions Dimensions	ca. approx. env. Ø 84 cm x H 34 cm	ca. approx. env. Ø 84 cm x H 34 cm
Gewicht Weight Poids	ca. approx. env. 7 kg	ca. approx. env. 7 kg
DE Material	ABS, PMMA glänzend, beschichtet, UV-beständig	ABS, PMMA glänzend, beschichtet, UV-beständig
Farbe	weiß, transluzent	weiß, transluzent
Lampenfassung/Watt	1x E27/ max. 40 W E27	1x E27/ max. 40 W E27
Leuchtmittel	LED Leuchtmittel E27, max. 5,5 W, EEC: F, max. 500 lm Lebensdauer: 15.000 h	Multicolor LED Leuchtmittel E27, max. 9 W, EEC: F, max. 850 lm Lebensdauer: 50.000 h
Fernbedienung	-	mit Fernbedienung
Aufladbarer Akku/ Ladezeit Laufzeit (in Farbwechsel)	-	-
Ladegerät	-	-
Verkabelung	ca. 3 m mit Fußschalter, klar	ca. 3 m mit Fußschalter, klar
Spannung	230 V~, 50 Hz	230 V~, 50 Hz
Schutzklasse	II	II
Für Innenbereich	Ja	Ja
Für Aussenbereich	-	-
EN Material	ABS, PMMA coated, gloss finish, UV resistant	ABS, PMMA coated, gloss finish, UV resistant
Colour	white, translucent	white, translucent
Lamp Holder	1x E27/ max. 40 W E27	1x E27/ max. 40 W E27
Illuminant	LED bulb E27, max. 5,5 W, EEC: F, max. 500 lm Life span: 15.000 h	LED multicolour light bulb E27, max. 9 W, EEC: F, max. 850 lm, Life span: 50.000 h
Remote Control	-	with Radio remote control
Rechargeable battery/ ChargingTime Runtime (in colour change)	-	-
Charger	-	-
Cable	approx. 3 m cable, clear	approx. 3 m cable, clear
Voltage	230 V~, 50 Hz	230 V~, 50 Hz
Protection Class	II	II
For Indoor Use	Yes	Yes
For Outdoor Use	-	-
FR Matériaux	ABS, PMMA, brillant, résistant aux rayons UV	ABS, PMMA, brillant, résistant aux rayons UV
Couleur	blanc, translucide	blanc, translucide
Support de Lampe	1x E27/ max. 40 W E27	1x E27/ max. 40 W E27
Ampoule	illuminant à DEL E27, max. 5,5 W, CÉ: F, max. 500 lm Durée de vie: 15.000 h	LED multicolours E27 max. 9 W, CÉ: F, max. 850 lm Durée de vie: 50.000 h
Télécommande	-	avec télécommande radio
Batterie/ Temps de Charge Autonomie (en changement de couleur)	-	-
Chargeur	-	-
Câblage	env. 3 m, transparent	env. 3 m, transparent
Tension	230 V~, 50 Hz	230 V~, 50 Hz
Catégorie	II	II
Pour Utilisation Intérieur	Oui	Oui
Pour Utilisation Extérieure	-	-

LOUNGE OUTDOOR

04-03-01

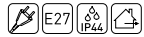

ca. | approx. | env. Ø 84 cm x H 34 cm

ca. | approx. | env. 8 kg

ABS, PMMA glänzend, beschichtet,
UV-beständig

weiß, transluzent

1x E27/ max. 40 W E27

LED-Leuchtmittel E27, 5.5W, 500 Lm,
Warmweiß (3000 K), EEK: F
Lebensdauer: 15.000 h

-

-

-

ca. 5 m, schwarz

230 V~, 50 Hz

II

-

IP44

LOUNGE OUTDOOR LED

04-03-01-LED



ca. | approx. | env. Ø 84 cm x H 34 cm

ca. | approx. | env. 8 kg

ABS, PMMA glänzend, beschichtet,
UV-beständig

weiß, transluzent

1x E27/ max. 40 W E27

Multicolor LED Leuchtmittel E27,
max. 9 W, EEK: F, max. 850 lm,
Lebensdauer: 50.000 h

mit Funkfernbedienung

-

-

ca. 5 m Kabel, schwarz

230 V~, 50Hz

II

-

IP44

LOUNGE LED ACCU OUTDOOR

04-09-01



ca. | approx. | env. Ø 84 cm x H 34 cm

ca. | approx. | env. 7 kg

ABS, PMMA glänzend, beschichtet,
UV-beständig

weiß, transluzent

Eingebaute LED-Einheit (ausbaubar)

Multicolor & Warmweiß 2700 K,
Kaltweiß 6000 K LEDs, max. 7.2 W,
max. 810 lm, Lebensdauer: 30000 h

IR

3.7 V, 2 x 2600 mAh (Li-Ion)/ 10 Std.
11 Std.

100-240 V~, 50/60 Hz, Vout 5 V, 1,2 A

1,2 m

100-240 VAC, 50/ 60 Hz

III (Produkt), II (Ladegerät)

-

IP54

ABS, PMMA coated, gloss finish,
UV resistant

white, translucent

1x E27/ max. 40 W E27

LED bulb E27,
max. 5,5 W, EEC: F, max. 500 lm
Life span: 15.000 h

-

-

-

approx. 5 m, black

230 V~, 50 Hz

II

-

IP44

ABS, PMMA coated, gloss finish,
UV resistant

white, translucent

1x E27/ max. 40 W E27

LED multicolor light bulb E27,
max. 9 W EEC: F, max. 850 lm,
Life span: 50.000 h

with Radio remote control

-

-

approx. 5 m cable, black

230 V~, 50Hz

II

-

IP44

ABS, PMMA coated, gloss finish,
UV resistant

white, translucent

Built-In LED Unit (removable)

Multicolor & warm white 2700 K,
cool white 6000 K LEDs, max. 7.2 W,
max. 810 lm, life span: 30000 h

IR

3.7 V, 2 x 2600 mAh (Li-Ion)/ 10 h
11 h

100-240 V~, 50/60 Hz, Vout 5 V, 1,2 A

1,2 m

100-240 VAC, 50/ 60 Hz

III (Product), II (Charger)

-

IP54

ABS, PMMA, brillant,
résistant aux rayons UV

blanc, translucide

1x E27/ max. 40 W E27

luminant à DEL E27,
max. 5,5 W, CÉ: F, max. 500 lm
Durée de vie: 15.000 h

-

-

-

env. 5 m, noir

230 V~, 50 Hz

II

-

IP44

ABS, PMMA, brillant,
résistant aux rayons UV

blanc, translucide

1x E27/ max. 40 W E27

LED multicoloreurs E27m
ax. 9 W, CÉ: F, max. 850 lm
Durée de vie: 50.000 h

avec télécommande radio

-

-

env. 5 m, noir

230 V~, 50Hz

II

-

IP44

ABS, PMMA, brillant,
résistant aux rayons UV

blanc, translucide

Unité à LED intégrée (amovible)

DEL multicolores & blanc chaud 2700
K, blanc froid 6000 K, max. 7,2 W,
max. 810 lm, durée de vie: 30000 h

IR

3.7 V, 2 x 2600 mAh (Li-Ion)/ 10 h
12 h

100-240 V~, 50/60 Hz, Vout 5 V, 1,2 A

1,2 m

100-240 VAC, 50/ 60 Hz

III (Objet), II (Chargeur)



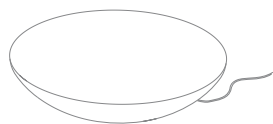

-

IP54

LOUNGE VARIATION



Inklusive: 5 mm Glasplatte
Including: 5 mm glass top
Inclus: 5 mm tablette en verre

	LOUNGE VARIATION 07-01-01	LOUNGE VARIATION LED PRO 07-03-01
Modell Model Modèle	07-01-01	07-03-01
	 E27 	 E27  
Maße Dimensions Dimensions	ca. approx. env. Ø 84 cm x H 18 cm	ca. approx. env. Ø 84 cm x H 18 cm
Gewicht Weight Poids	ca. approx. env. 8 kg	ca. approx. env. 9 kg
DE Material	ABS, PMMA glänzend beschichtet, UV-beständig	ABS, PMMA glänzend beschichtet, UV-beständig
Farbe	weiß, transluzent	weiß, transluzent
Lampenfassung	1x E27/ max. 40 W E27	1x E27/ max. 40 W E27
Leuchtmittel	LED Leuchtmittel E27, max. 5,5 W, EEC: F, max. 500 lm Lebensdauer: 15.000 h	Multicolor LED Leuchtmittel E27, max. 9 W, EEC: F, max. 850 lm Lebensdauer: 50.000 h
Fernbedienung	-	mit Fernbedienung
Aufladbarer Akku/ Ladezeit Laufzeit (in Farbwechsel)	-	-
Ladegerät	-	-
Verkabelung	ca. 3,5 m , klar	ca. 3,5 m , klar
Spannung	230 V~, 50 Hz	230 V~, 50 Hz
Schutzklasse	II	II
Für Innenbereich	Ja	Ja
Für Aussenbereich	-	-
EN Material	ABS, PMMA coated, gloss finish, UV resistant	ABS, PMMA coated, gloss finish, UV resistant
Colour	white, translucent	white, translucent
Lamp Holder	1x E27/ max. 40 W E27	1x E27/ max. 40 W E27
Illuminant	LED bulb E27, max. 5,5 W, EEC: F, max. 500 lm Life span: 15.000 h	LED multicolour light bulb E27, max. 9 W, EEC: F, max. 850 lm, Life span: 50.000 h
Remote Control	-	with Radio remote control
Rechargeable battery/ ChargingTime Runtime (in colour change)	-	-
Charger	-	-
Cable	approx. 3.5 m, clear	approx. 3.5 m, clear
Voltage	230 V~, 50 Hz	230 V~, 50 Hz
Protection Class	II	II
For Indoor Use	Yes	Yes
For Outdoor Use	-	-
FR Matériaux	ABS, PMMA, brillant, résistant aux rayons UV	ABS, PMMA, brillant, résistant aux rayons UV
Couleur	blanc, translucide	blanc, translucide
Support de Lampe	1x E27/ max. 40 W E27	1x E27/ max. 40 W E27
Ampoule	illuminant à DEL E27, max. 5,5 W, CÉ: F, max. 500 lm Durée de vie: 15.000 h	LED multicolours E27, max. 9 W, CÉ: F, max. 850 lm, Durée de vie: 50.000 h
Télécommande	-	avec télécommande radio
Batterie/ Temps de Charge Autonomie (en changement de couleur)	-	-
Chargeur	-	-
Câblage	env. 3,5 m, transparent	env. 3,5 m, transparent
Tension	230 V~, 50 Hz	230 V~, 50 Hz
Catégorie	II	II
Pour Utilisation Intérieur	Oui	Oui
Pour Utilisation Extérieure	-	-

LOUNGE VARIATION OUTDOOR

07-02-01

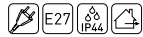

ca. | approx. | env. Ø 84 cm x H 18 cm

ca. | approx. | env. 9 kg

ABS, PMMA glänzend
beschichtet, UV-beständig

weiß, transluzent

1x E27/ max. 40 W E27

LED Leuchtmittel E27,
max. 5,5 W, EEC: F, max. 500 lm
Lebensdauer: 15.000 h

-

-

-

-

ca. 4,5 m, schwarz

230 V~, 50 Hz

II

-

-

IP44

L. VARIATION LED PRO OUTDOOR

07-03-02



ca. | approx. | env. Ø 84 cm x H 18 cm

ca. | approx. | env. 9 kg

ABS, PMMA glänzend
beschichtet, UV-beständig

weiß, transluzent

1x E27/ max. 40 W E27

Multicolor LED Leuchtmittel E27,
max. 9 W, EEC: F, max. 850 lm
Lebensdauer: 50.000 h

mit Funkfernbedienung

-

-

-

ca. 4,5 m, schwarz

230 V~, 50 Hz

II

-

-

IP44

L. VARIATION LED ACCU OUTDOOR

07-13-01



ca. | approx. | env. Ø 84 cm x H 18 cm

ca. | approx. | env. 9 kg

ABS, PMMA glänzend
beschichtet, UV-beständig

weiß, transluzent

Eingebaute LED-Einheit (ausbaubar)

Multicolor & Warmweiß 2700 K,
Kaltweiß 6000 K LEDs, max. 7,2 W,
max. 810 lm, Lebensdauer: 30000 h

IR

3.7 V, 2 x 2600 mAh (Li-Ion)/ 10 h
11 h

100-240 V~, 50/60 Hz, Vout 5 V, 1,2 A

1,2 m

100-240 VAC, 50/ 60 Hz

III (Produkt), II (Ladegerät)

-

-

IP54

ABS, PMMA coated, gloss finish,
UV resistant

white, translucent

1x E27/ max. 40 W E27

LED bulb E27,
max. 5,5 W, EEC: F, max. 500 lm
Life span: 15.000 h

-

-

-

-

approx. 4.5 m, black

230 V~, 50 Hz

II

-

-

IP44

ABS, PMMA coated, gloss finish,
UV resistant

white, translucent

1x E27/ max. 40 W E27

LED multicolour light bulb E27,
max. 9 W, EEC: F, max. 850 lm,
Life span: 50.000 h

with Radio remote control

-

-

-

approx. 4.5 m, black

230 V~, 50 Hz

II

-

-

IP44

ABS, PMMA coated, gloss finish,
UV resistant

white, translucent

Built-In LED Unit (removable)

Multicolor & warm white 2700 K,
cool white 6000 K LEDs, max. 7.2 W,
max. 810 lm, life span: 30000 h

IR

3.7 V, 2 x 2600 mAh (Li-Ion)/ 10 h
11 h

100-240 V~, 50/60 Hz, Vout 5 V, 1,2 A

1,2 m

100-240 VAC, 50/ 60 Hz

III (Product), II (Charger)

-

-

IP54

ABS, PMMA, brillant,
résistant aux rayons UV

blanc, translucide

1x E27/ max. 40 W E27

illuminant à DEL E27,
max. 5,5 W, CÉ: F, max. 500 lm
Durée de vie: 15.000 h

-

-

-

-

env. 4.5 m, noir

230 V~, 50 Hz

II

-

-

IP44

ABS, PMMA, brillant,
résistant aux rayons UV

blanc, translucide

1x E27/ max. 40 W E27

LED multicolours E27,
max. 9 W, CÉ: F, max. 850 lm,
Durée de vie: 50.000 h

avec télécommande radio

-

-

-

env. 4.5 m, noir

230 V~, 50 Hz

II

-

-

IP44

ABS, PMMA, brillant,
résistant aux rayons UV

blanc, translucide

Unité à LED intégrée (amovible)

DEL multicolores & blanc chaud 2700
K, blanc froid 6000 K, max. 7,2 W,
max. 810 lm, durée de vie: 30000 h

IR

3.7 V, 2 x 2600 mAh (Li-Ion)/ 10 h
11 h

Vout 7.5 V / 0,6 A

1,2 m

100-240 VAC, 50/ 60 Hz

III (Objet), II (Chargeur)

-

-

IP54

LOUNGE

45 | 55 | 75 | 105



Inklusive: 5 mm Glasplatte
Including: 5 mm glass top
Inclus: 5 mm tablette en verre

	LOUNGE INDOOR	LOUNGE LED PRO
Modell Model Modèle	45: 07-06-04 75: 07-06-02	55: 07-06-01 105: 07-06-03
	  	    
Maße Dimensions Dimensions	ca. l approx. l env. Ø 84 x H 45/55/75/105 cm	ca. l approx. l env. Ø 84 x H 45/55/75/105 cm
Gewicht Weight Poids	ca. l approx. l env. 24.4/24.9/25.1/31.5 kg	ca. l approx. l env. 24.4/24.9/25.1/31.5 kg
DE Material/ Farbe	ABS, PMMA glänzend, weiß transluzent, UV-beständig; Aluminium gebürstet	ABS, PMMA glänzend, weiß transluzent, UV-beständig; Aluminium gebürstet
Lampenfassung	1x E27/ max. 40 W E27	1x E27/ max. 40 W E27
Leuchtmittel	LED Leuchtmittel E27, max. 5,5 W, EEC: F, max. 500 lm Lebensdauer: 15.000 h	Multicolor LED Leuchtmittel E27, max. 9 W, EEC: F, max. 850 lm Lebensdauer: 50.000 h
Fernbedienung	-	mit Funkfernbedienung
Aufladbarer Akku/ Ladezeit Laufzeit (in Farbwechsel)	-	-
Ladegerät	-	-
Verkabelung	ca. 2,5 - 3 m, klar	ca. 2,5 - 3 m, klar
Spannung	230 V~, 50 Hz	230 V~, 50 Hz
Schutzklasse	II	II
Für Innenbereich	Ja	Ja
Für Aussenbereich	-	-
EN Material/ Colour	ABS, PMMA glossy, white translucent UV resistant; aluminium brushed	ABS, PMMA glossy, white translucent UV resistant; aluminium brushed
Lamp Holder	1x E27/ max. 40 W E27	1x E27/ max. 40 W E27
Illuminant	LED bulb E27, max. 5,5 W, EEC: F, max. 500 lm Life span: 15.000 h	LED multicolour light bulb E27, max. 9 W, EEC: F, max. 850 lm, Life span: 50.000 h
Remote Control	-	with Radio remote control
Rechargeable battery/ ChargingTime Runtime (in colour change)	-	-
Charger	-	-
Cable	2,5 - 3 m, clear	2,5 - 3 m, clear
Voltage	230 V~, 50 Hz	230 V~, 50 Hz
Protection Class	II	II
For Indoor Use	Yes	Yes
For Outdoor Use	-	-
FR Matériaux/ Couleur	ABS, PMMA brillant, blanc, translucide résistant aux rayons UV; Aluminium brossé	ABS, PMMA brillant, blanc, translucide résistant aux rayons UV; Aluminium brossé
Support de Lampe	1x E27/ max. 40 W E27	1x E27/ max. 40 W E27
Ampoule	Illuminant à DEL E27, max. 5,5 W, CÉ: F, max. 500 lm Durée de vie: 15.000 h	LED multicolours E27, max. 9 W, CÉ: F, max. 850 lm, Durée de vie: 50.000 h
Télécommande	-	avec télécommande radio
Batterie/ Temps de Charge Autonomie (en changement de couleur)	-	-
Chargeur	-	-
Câblage	env. 2,5 - 3 m, transparent	env. 2,5 - 3 m, transparent
Tension	230 V~, 50 Hz	230 V~, 50 Hz
Catégorie	II	II
Pour Utilisation Intérieur	Oui	Oui
Pour Utilisation Extérieure	-	-

LOUNGE OUTDOOR

45: 07-07-04 55: 07-07-01
75: 07-07-02 105: 07-07-03

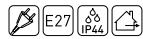

ca. | approx. | env. Ø 84 x H 45/55/75/105 cm
ca. | approx. | env. 24.4/24.9/25.1/31.5 kg

ABS, PMMA glänzend, weiß transluzent,
UV-beständig; Aluminium gebürstet

1x E27/ max. 40 W E27

LED Leuchtmittel E27,
max. 5,5 W, EEC: F, max. 500 lm
Lebensdauer: 15.000 h

-

-

-

-

ca. 3,5 - 4 m, schwarz

230 V~, 50 Hz

II

-

IP44

LOUNGE LED PRO OUTDOOR

45: 07-08-06 55: 07-08-07
75: 07-08-08 105: 07-08-05



ca. | approx. | env. Ø 84 x H 45/55/75/105 cm
ca. | approx. | env. 24.4/24.9/25.1/31.5 kg

ABS, PMMA glänzend, weiß transluzent,
UV-beständig; Aluminium gebürstet

1x E27/ max. 40 W E27

Multicolor LED Leuchtmittel E27,
max. 9 W mit Fernbedienung, EEC: F,
max. 850 lm, Lebensdauer: 50.000 h
mit Funkfernbedienung

-

-

-

ca. 5 m, schwarz

230 V~, 50Hz

II

-

IP44

LOUNGE LED ACCU OUTDOOR

45: 07-11-04 55: 07-11-01
75: 07-11-02 105: 07-11-03



ca. | approx. | env. Ø 84 x H 45/55/75/105 cm
ca. | approx. | env. 24.4/24.9/25.1/31.5 kg

ABS, PMMA glänzend, weiß transluzent,
UV-beständig; Aluminium gebürstet

Eingebaute LED-Einheit [ausbaubar]

Multicolor & Warmweiß 2700 K,
Kaltweiß 6000 K LEDs, max. 7.2 W,
max. 810 lm, Lebensdauer: 30000 h

IR

3.7 V, 2 x 2600 mAh (Li-Ion)/ 10 h
11 h

100-240 V~, 50/60 Hz, Vout 5 V, 1,2 A

1,2 m

100-240 VAC, 50/ 60 Hz

III (Produkt), II (Ladegerät)

-

IP54

ABS, PMMA glossy, white translucent
UV resistant; aluminium brushed

1x E27/ max. 40 W E27

LED bulb E27,
max. 5,5 W, EEC: F, max. 500 lm
Life span: 15.000 h

-

-

-

-

3,5 - 4 m, black

230 V~, 50 Hz

II

-

IP44

ABS, PMMA glossy, white translucent
UV resistant; aluminium brushed

1x E27/ max. 40 W E27

LED multicolor light bulb E27,
max. 9 W, EEC: F, max. 850 lm,
Lifespan: 50.000 h

with Radio remote control

-

-

-

approx. 5 m, black

230 V~, 50Hz

II

-

IP44

ABS, PMMA glossy, white translucent
UV resistant; aluminium brushed

Built-In LED Unit [removable]

Multicolor & warm white 2700 K,
cool white 6000 K LEDs, max. 7.2 W,
max. 810 lm, life span: 30000 h

IR

3.7 V, 2 x 2600 mAh (Li-Ion)/ 10 h
11 h

100-240 V~, 50/60 Hz, Vout 5 V, 1,2 A

1,2 m

100-240 VAC, 50/ 60 Hz

III (Product), II (Charger)

-

IP54

ABS, PMMA brillant, blanc, translucide
résistant aux rayons UV; Aluminium
brossé

1x E27/ max. 40 W E27

illuminant à DEL E27,
max. 5,5 W, CE: F, max. 500 lm
Durée de vie: 15.000 h

-

-

-

-

env. 3,5 - 4 m, noir

230 V~, 50 Hz

II

-

IP44

ABS, PMMA brillant, blanc, translucide
résistant aux rayons UV; Aluminium
brossé

1x E27/ max. 40 W E27

LED multicolours E27,
max. 9 W, CE: F, max. 850 lm,
Durée de vie: 50.000 h

avec télécommande radio

-

-

-

env. 5 m, noir

230 V~, 50Hz

II

-

IP44

ABS, PMMA brillant, blanc, translucide
résistant aux rayons UV; Aluminium
brossé

Unité à LED intégrée (amovible)

DEL multicolores & blanc chaud 2700
K, blanc froid 6000 K, max. 7,2 W,
max. 810 lm, durée de vie: 30000 h

IR

3.7 V, 2 x 2600 mAh (Li-Ion)/ 10 h
11 h

100-240 V~, 50/60 Hz, Vout 5 V, 1,2 A

1,2 m

100-240 VAC, 50/ 60 Hz

III (Objet), II (Chargeur)

-







IP54

LOUNGE M

45 | 55 | 75 | 105



Inklusive: 5 mm Glasplatte
Including: 5 mm glass top
Inclus: 5 mm tablette en verre

	LOUNGE M INDOOR	LOUNGE M INDOOR LED
Modell Model Modèle	45: 27-02-45 75: 27-02-75	55: 27-02-55 105: 27-02-105
	  	    
Maße Dimensions Dimensions	ca. approx. env. Ø 60 x H 45/55/75/105 cm	ca. approx. env. Ø 60 x H 45/55/75/105 cm
Gewicht Weight Poids	ca. approx. env. 15.1/15.3/15.7/20.0 kg	ca. approx. env. 15.1/15.3/15.7/20.0 kg
DE Material/ Farbe	ABS, PMMA glänzend, weiß transluzent, UV-beständig; Aluminium gebürstet	ABS, PMMA glänzend, weiß transluzent, UV-beständig; Aluminium gebürstet
Lampenfassung	1x E27/ max. 40 W E27	1x E27/ max. 40 W E27
Leuchtmittel	LED Leuchtmittel E27, max. 5,5 W, EEC: F, max. 500 lm Lebensdauer: 15.000 h	Multicolor LED Leuchtmittel E27, max. 9 W, EEC: F, max. 850 lm Lebensdauer: 50.000 h
Fernbedienung	-	mit Fernbedienung
Aufladbarer Akku/ Ladezeit Laufzeit (in Farbwechsel)	-	-
Ladegerät	-	-
Verkabelung	ca. 3,4/ 3,3/ 3,1/ 2,8 m, klar	ca. 3,4/ 3,3/ 3,1/ 2,8 m, klar
Spannung	230 V~, 50 Hz	230 V~, 50 Hz
Schutzklasse	II	II
Für Innenbereich	Ja	Ja
Für Aussenbereich	-	-
EN Material/ Colour	ABS, PMMA glossy, white translucent UV resistant; aluminium brushed	ABS, PMMA glossy, white translucent UV resistant; aluminium brushed
Lamp Holder	1x E27/ max. 40 W E27	1x E27/ max. 40 W E27
Illuminant	LED bulb E27, max. 5,5 W, EEC: F, max. 500 lm Life span: 15.000 h	LED multicolour light bulb E27, max. 9 W, EEC: F, max. 850 lm, Life span: 50.000 h
Remote Control	-	with Radio remote control
Rechargeable battery/ ChargingTime Runtime (in colour change)	-	-
Charger	-	-
Cable	approx. 3,4/ 3,3/ 3,1/ 2,8 m, clear	approx. 3,4/ 3,3/ 3,1/ 2,8 m, clear
Voltage	230 V~, 50 Hz	230 V~, 50 Hz
Protection Class	II	II
For Indoor Use	Yes	Yes
For Outdoor Use	-	-
FR Matériaux/ Couleur	ABS, PMMA brillant, blanc, translucide résistant aux rayons UV; Aluminium brossé	ABS, PMMA brillant, blanc, translucide résistant aux rayons UV; Aluminium brossé
Support de Lampe	1x E27/ max. 40 W E27	1x E27/ max. 40 W E27
Ampoule	illuminant à DEL E27, max. 5,5 W, CÉ: F, max. 500 lm Durée de vie: 15.000 h	LED multicolours E27, max. 9 W, CÉ: F, max. 850 lm, Durée de vie: 50.000 h
Télécommande	-	avec télécommande radio
Batterie/ Temps de Charge Autonomie (en changement de couleur)	-	-
Chargeur	-	-
Câblage	env. 3,4/ 3,3/ 3,1/ 2,8 m, transparent	env. 3,4/ 3,3/ 3,1/ 2,8 m, transparent
Tension	230 V~, 50 Hz	230 V~, 50 Hz
Catégorie	II	II
Pour Utilisation Intérieure	Oui	Oui
Pour Utilisation Extérieure	-	-

LOUNGE M OUTDOOR

45: 27-07-45 55: 27-07-55
75: 27-07-75 105: 27-07-105

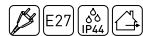

ca. | approx. | env. Ø 60 x H 45/55/75/105 cm
ca. | approx. | env. 15.1/15.3/15.7/20.0 kg

ABS, PMMA glänzend, weiß transluzent,
UV-beständig; Aluminium gebürstet

1x E27/ max. 40 W E27

LED Leuchtmittel E27,
max. 5,5 W, EEC: F, max. 500 lm
Lebensdauer: 15.000 h

-

-

-

-

ca. 4,4/ 4,3/ 4,1/ 3,8 m, schwarz

230 V~, 50 Hz

II

-

-

-

-

-

-

-

-

-

-

-

-

-

-

-

-

-

-

-

-

-

-

-

-

-

-

-

-

-

-

-

-

-

-

-

-

-

-

-

-

-

-

LOUNGE M OUTDOOR LED

45: 27-05-45 55: 27-05-55
75: 27-05-75 105: 27-05-105



ca. | approx. | env. Ø 60 x H 45/55/75/105 cm
ca. | approx. | env. 15.1/15.3/15.7/20.0 kg

ABS, PMMA glänzend, weiß transluzent,
UV-beständig; Aluminium gebürstet

1x E27/ max. 40 W E27

Multicolor LED Leuchtmittel E27,
max. 9 W, EEC: F, max. 850 lm,
Lebensdauer: 50.000 h

mit Funkfernbedienung

-

-

-

-

ca. 4,4/ 4,3/ 4,1/ 3,8 m, schwarz

230 V~, 50 Hz

II

-

-

-

-

-

-

-

-

-

-

-

-

-

-

-

-

-

-

-

-

-

-

-

-

-

-

-

-

-

-

-

-

-

-

-

-

-

-

-

-

-

-

LOUNGE M LED ACCU OUTDOOR

45: 27-03-45 55: 27-03-55
75: 27-03-75 105: 27-03-105



ca. | approx. | env. Ø 60 x H 45/55/75/105 cm
ca. | approx. | env. 15.1/15.3/15.7/20.0 kg

ABS, PMMA glänzend, weiß transluzent,
UV-beständig; Aluminium gebürstet

Eingebaute LED-Einheit (ausbaubar)

Multicolor & Warmweiß 2700 K,
Kaltweiß 6000 K LEDs, max. 7,2 W,
max. 810 lm, Lebensdauer: 30000 h

IR

3,7 V, 2 x 2600 mAh (Li-Ion)/ 10 h

11 h

100-240 V~, 50/60 Hz, Vout 5 V, 1,2 A

1,2 m

100-240 VAC, 50/ 60 Hz

III (Produkt), II (Ladegerät)

-

-

-

-

-

-

-

-

-

-

-

-

-

-

-

-

-

-

-

-

-

-

-

-

-

-

-

-

-

-

-

-

-

-

-

-

-

-

-

-



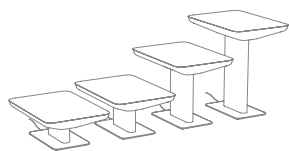

-

-

STUDIO 36 | 45 | 75 | 105



Inklusive: 5 mm Glasplatte
Including: 5 mm glass top
Inclus: 5 mm tablette en verre

	STUDIO 36/ 45/ 75/ 105 INDOOR		STUDIO LED PRO	
Modell Model Modèle	36: 16-02-01	45: 16-02-02	36: 16-04-01	45: 16-04-02
	75: 16-02-03	105: 16-02-04	75: 16-04-03	105: 16-04-04
	 E27 		  	
Maße Dimensions Dimensions	ca. approx. env. 70x100 H 36/45/75/105 cm		ca. approx. env. 70x100 H 36/45/75/105 cm	
Gewicht Weight Poids	ca. approx. env. 34.9/35.7/38.6/41.6 kg		ca. approx. env. 34.9/35.7/38.6/41.6 kg	
DE Material/ Farbe	ABS, PMMA glänzend, weiß transluzent, UV-beständig; Edelstahl gebürstet		ABS, PMMA glänzend, weiß transluzent, UV-beständig; Edelstahl gebürstet	
Lampenfassung	1x E27/ max. 40 W E27		1x E27/ max. 40 W E27	
Leuchtmittel	LED Leuchtmittel E27, max. 5,5 W, EEC: F, max. 500 lm Lebensdauer: 15.000 h		Multicolor LED Leuchtmittel E27, max. 9 W, EEC: F, max. 850 lm Lebensdauer: 50.000 h	
Fernbedienung	-		mit Funkfernbedienung	
Aufladbarer Akku/ Ladezeit Laufzeit (in Farbwechsel)	-		-	
Ladegerät	-		-	
Verkabelung	ca. 2,5 - 3 m, klar		ca. 2,5 - 3 m, transparent	
Spannung	200-240 VAC, 50 Hz		200-240 VAC, 50 Hz / MAX 15 W	
Schutzklasse	II		II	
Für Innenbereich	Ja		Ja	
Für Aussenbereich	-		-	
EN Material/ Colour	ABS, PMMA glossy, white translucent UV resistant; Stainless steel brushed		ABS, PMMA glossy, white translucent UV resistant; Stainless steel brushed	
Lamp Holder	1x E27/ max. 40 W E27		1x E27/ max. 40 W E27	
Illuminant	LED bulb E27, max. 5,5 W, EEC: F, max. 500 lm Life span: 15.000 h		LED multicolour light bulb E27, max. 9 W, EEC: F, max. 850 lm, Life span: 50.000 h	
Remote Control	-		with Radio remote control	
Rechargeable battery/ ChargingTime Runtime (in colour change)	-		-	
Charger	-		-	
Cable	2,5 - 3 m, clear		2,5 - 3 m, transparent	
Voltage	200-240 VAC, 50 Hz		200-240 VAC, 50 Hz / MAX. 15 W	
Protection Class	II		II	
For Indoor Use	Yes		Yes	
For Outdoor Use	-		-	
FR Matériaux/ Couleur	ABS, PMMA brillant, blanc, translucide résistant aux rayons UV; acier inoxydable brossé		ABS, PMMA brillant, blanc, translucide résistant aux rayons UV; acier inoxydable brossé	
Support de Lampe	1x E27/ max. 40 W E27		1x E27/ max. 40 W E27	
Ampoule	Illuminant à DEL E27, max. 5,5 W, CÉ: F, max. 500 lm Durée de vie: 15.000 h		LED multicolours E27, max. 9 W, CÉ: F, max. 850 lm, Durée de vie: 50.000 h	
Télécommande	-		avec télécommande radio	
Batterie/ Temps de Charge Autonomie (en changement de couleur)	-		-	
Chargeur	-		-	
Câblage	env. 2,5 - 3 m, transparent		env. 2,5 - 3 m, transparent	
Tension	200-240 VAC, 50 Hz		200-240 VAC, 50 Hz / MAX. 15 W	
Catégorie	II		II	
Pour Utilisation Intérieure	Oui		Oui	
Pour Utilisation Extérieure	-		-	

STUDIO OUTDOOR

36: 16-03-01 45: 16-03-02
75: 16-03-03 105: 16-03-04

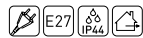

ca. | approx. | env. 70x100 H 36/45/75/105 cm
ca. | approx. | env. 34.9/35.7/38.6/41.6 kg

ABS, PMMA glänzend, weiß transluzent,
UV-beständig; Edelstahl gebürstet

1x E27/ max. 40 W E27

LED Leuchtmittel E27,
max. 5,5 W, EEK: F, max. 500 lm
Lebensdauer: 15.000 h

-

-

-

-

ca. 3,5 - 4 m, schwarz

230 V~, 50 Hz

II

-

IP44

STUDIO OUTDOOR LED

36: 16-03-01 LED 45: 16-03-02 LED
75: 16-05-03 LED 105: 16-05-04 LED



ca. | approx. | env. 70x100 H 36/45/75/105 cm
ca. | approx. | env. 34.9/35.7/38.6/41.6 kg

ABS, PMMA glänzend, weiß transluzent,
UV-beständig; Edelstahl gebürstet

1x E27/ max. 40 W E27

Multicolor LED Leuchtmittel E27,
max. 9 W, EEK: F, max. 850 lm
Lebensdauer: 50.000 h

mit Funkfernbedienung

-

-

-

ca. 3,5 - 4 m, schwarz

230 V~, 50 Hz

II

-

IP44

STUDIO LED ACCU OUTDOOR

36: 16-08-01 45: 16-08-02
75: 16-08-03 105: 16-08-04



ca. | approx. | env. 70x100 H 36/45/75/105 cm
ca. | approx. | env. 34.9/35.7/38.6/41.6 kg

ABS, PMMA glänzend, weiß transluzent,
UV-beständig; Edelstahl gebürstet

Eingebaute LED-Einheit (ausbaubar)

Multicolor & Warmweiß 2700 K,
Kaltweiß 6000 K LEDs, max. 7.2 W,
max. 810 lm, Lebensdauer: 30000 h

IR

3.7 V, 2 x 2600 mAh (Li-Ion)/ 10 h
11 h

100-240 V~, 50/60 Hz, Vout 5 V, 1,2 A

1,2 m

100-240 VAC, 50/ 60 Hz

III (Produkt), II (Ladegerät)

-

IP54

ABS, PMMA glossy, white translucent
UV resistant; Stainless steel brushed

1x E27/ max. 40 W E27

LED bulb E27,
max. 5,5 W, EEC: F, max. 500 lm
Life span: 15.000 h

-

-

-

-

3,5 - 4 m, black

230 V~, 50 Hz

II

-

IP44

ABS, PMMA glossy, white translucent
UV resistant; Stainless steel brushed

1x E27/ max. 40 W E27

LED multicolour light bulb E27,
max. 9 W, EEC: F, max. 850 lm,
Life span: 50.000 h

with Radio remote control

-

-

-

approx. 3.5-4 m, black

230 V~, 50 Hz

II

-

IP44

ABS, PMMA glossy, white translucent
UV resistant; Stainless steel brushed

Built-In LED Unit (removable)

Multicolor & warm white 2700 K,
cool white 6000 K LEDs, max. 7.2 W,
max. 810 lm, life span: 30000 h

IR

3.7 V, 2 x 2600 mAh (Li-Ion)/ 10 h
11 h

100-240 V~, 50/60 Hz, Vout 5 V, 1,2 A

1,2 m

100-240 VAC, 50/ 60 Hz

III (Product), II (Charger)

-

IP54

ABS, PMMA brillant, blanc, translucide
résistant aux rayons UV;
acier inoxydable brossé

1x E27/ max. 40 W E27

illuminant à DEL E27,
max. 5,5 W, CÉ: F, max. 500 lm
Durée de vie: 15.000 h

-

-

-

-

env. 3,5 - 4 m, noir

230 V~, 50 Hz

II

-

IP44

ABS, PMMA brillant, blanc, translucide
résistant aux rayons UV;
acier inoxydable brossé

1x E27/ max. 40 W E27

LED multicolours E27,
max. 9 W, CÉ: F, max. 850 lm,
Durée de vie: 50.000 h

avec télécommande radio

-

-

-

env. 3,5 - 4 m, noir

230 V~, 50 Hz

II

-

IP44

ABS, PMMA brillant, blanc, translucide
résistant aux rayons UV;
acier inoxydable brossé

Unité à LED intégrée (amovible)

DEL multicolores & blanc chaud 2700
K, blanc froid 6000 K, max. 7,2 W,
max. 810 lm, durée de vie: 30000 h

IR

3.7 V, 2 x 2600 mAh (Li-Ion)/ 10 h
11 h

100-240 V~, 50/60 Hz, Vout 5 V, 1,2 A

1,2 m

100-240 VAC, 50/ 60 Hz

III (Objet), II (Chargeur)

-

IP54

COOLER



LED-Akku-Einheit entnehmbar zum Laden
LED battery unit removable for charging
Unité de batterie LED amovible pour le chargement

COOLER LED ACCU OUTDOOR

Modell | Model | Modèle

14-01-02



DE	Material	PE seidenmatt, UV-beständig
	Farbe	weiß, transluzent
	Maße	ca. Ø 46 cm, H 89 cm
	Gewicht	ca. 10 kg
	Lampenfassung	LED-Einheit entnehmbar zum Laden
	Leuchtmittel	Multicolor & Warmweiß 2700 K, Kaltweiß 6000 K LEDs, max. 7.2 W, max. 810 lm, Lebensdauer: 30000 h
	Fernbedienung	IR
	Aufladbarer Akku/ Ladezeit	3.7 V, 2 x 2600 mAh (Li-Ion)/ 10 h
	Laufzeit (in Farbwechsel)	11 h
	Ladegerät	100-240 V~, 50/60 Hz, Vout 5 V, 1,2 A
	Verkabelung	1,2 m
	Spannung	100-240 VAC, 50/ 60 Hz
	Schutzklasse	III (Produkt), II (Ladegerät)
	Für Innenbereich	-
	Für Aussenbereich	IP54

EN	Material	PE semi gloss, UV resistant
	Colour	white, translucent
	Dimensions	approx. ca. Ø 46 cm, H 89 cm
	Weight	approx. 10 kg
	Lamp Holder	LED unit removable for charging
	Illuminant	Multicolor & warm white 2700 K, cool white 6000 K LEDs, max. 7.2 W, max. 810 lm, life span: 30000 h
	Remote Control	IR
	Rechargeable battery/ ChargingTime	3.7 V, 2 x 2600 mAh (Li-Ion)/ 10 h
	Runtime (in colour change)	11 h
	Charger	100-240 V~, 50/60 Hz, Vout 5 V, 1,2 A
	Cable	1,2 m
	Voltage	100-240 VAC, 50/ 60 Hz
	Protection Class	III (Product), II (Charger)
	For Indoor Use	-
	For Outdoor Use	IP54

FR	Matériaux	PE satiné, résistant aux rayons UV
	Couleur	blanc, translucide
	Dimensions	env. Ø 46 cm, H 89 cm
	Poids	env. 10 kg
	Support de Lampe	Unité LED amovible pour la charge
	Ampoule	DEL multicolores & blanc chaud 2700 K, blanc froid 6000 K, max. 7,2 W, max. 810 lm, durée de vie: 30000 h
	Télécommande	IR
	Rechargeable battery/ ChargingTime	3.7 V, 2 x 2600 mAh (Li-Ion)/ 10 h
	Runtime (in colour change)	11 h
	Chargeur	100-240 V~, 50/60 Hz, Vout 5 V, 1,2 A
	Câblage	1,2 m
	Tension	100-240 VAC, 50/ 60 Hz
	Catégorie	III (Produit), II (Chargeur)
	Pour Utilisation Intérieur	-
	Pour Utilisation Extérieure	IP54

BUBBLE

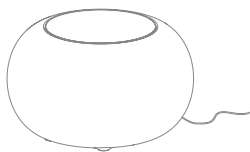



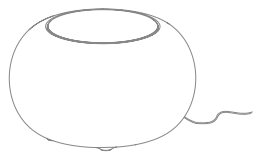

Inklusive: Glasplatte oder Sitzkissen
Including: Glass top or cushion
Inclus: Panneau de verre ou coussin

Modell Model Modèle	BUBBLE X 15-07-01	BUBBLE INDOOR 15-01-01
Maße Dimensions Dimensions	ca. approx. env. Ø 68 x H 41 cm	ca. approx. env. Ø 68 x H 41 cm
Gewicht Weight Poids	ca. approx. env. 7 kg	ca. approx. env. 7 kg
DE Material	PE seidenmatt, UV-beständig	PE seidenmatt, UV-beständig
Farbe	Weiß, transluzent	Weiß, transluzent
Lampenfassung	-	1x E27/ max. 40 W E27
Leuchtmittel	Ohne Beleuchtung	LED Leuchtmittel E27, max. 5,5 W, EEK: F, max. 500 lm Lebensdauer: 15.000 h
Fernbedienung	-	-
Aufladbarer Akku/ Ladezeit Laufzeit (in Farbwechsel)	-	-
Ladegerät	-	-
Verkabelung	-	ca. 3 m mit Fußschalter, klar
Spannung	-	230 V~, 50 Hz
Schutzklasse	-	II
Für Innenbereich	Ja	Ja
Für Aussenbereich	Ja	-
EN Material	PE semi gloss, UV resistant	PE semi gloss, UV resistant
Colour	White, translucent	White, translucent
Lamp Holder	-	1x E27/ max. 40 W E27
Illuminant	without Light	LED bulb E27, max. 5,5 W, EEC: F, max. 500 lm Life span: 15.000 h
Remote Control	-	-
Rechargeable battery/ Charging Time Runtime (in colour change)	-	-
Charger	-	-
Cable	-	approx. 3 m with foot switch, clear
Voltage	-	230 V~, 50 Hz
Protection Class	-	II
For Indoor Use	Yes	Yes
For Outdoor Use	Yes	-
FR Matériaux	PE satiné, résistant aux rayons UV	PE satiné, résistant aux rayons UV
Couleur	Blanc, translucide	Blanc, translucide
Support de Lampe	-	1x E27/ max. 40 W E27
Ampoule	sans lumière	illuminant à DEL E27, max. 5,5 W, CÉ: F, max. 500 lm Durée de vie: 15.000 h
Télécommande	-	-
Batterie/ Temps de Charge Autonomie (en changement de couleur)	-	-
Chargeur	-	-
Câblage	-	env. 3 m avec pédale, transparent
Tension	-	230 V~, 50 Hz
Catégorie	-	II
Pour Utilisation Intérieur	Oui	Oui
Pour Utilisation Extérieure	Oui	-

BUBBLE



Inklusive: Glasplatte oder Sitzkissen
Including: Glass top or cushion
Inclus: Panneau de verre ou coussin

Modell Model Modèle	BUBBLE INDOOR LED 15-01-01-LED	BUBBLE OUTDOOR 15-02-01
	   	  
Maße Dimensions Dimensions	ca. approx. env. Ø 68 x H 41 cm	ca. approx. env. Ø 68 x H 41 cm
Gewicht Weight Poids	ca. approx. env. 7 kg	ca. approx. env. 8 kg
DE Material	PE seidenmatt, UV-beständig	PE seidenmatt, UV-beständig
Farbe	Weiß, transluzent	Weiß, transluzent
Lampenfassung	1x E27/ max. 40 W E27	1x E27/ max. 40 W E27
Leuchtmittel	Multicolor LED Leuchtmittel E27, max. 9 W, EEC: F, max. 850 lm Lebensdauer: 50.000 h	LED Leuchtmittel E27, max. 5,5 W, EEC: F, max. 500 lm Lebensdauer: 15.000 h
Fernbedienung	mit Funkfernbedienung	-
Aufladbarer Akku/ Ladezeit Laufzeit (in Farbwechsel)	-	-
Ladegerät	-	-
Verkabelung	ca. 3 m mit Fußschalter, klar	ca. 5 m, schwarz
Spannung	230 V~, 50 Hz	230 V~, 50 Hz
Schutzklasse	II	II
Für Innenbereich	Ja	-
Für Aussenbereich	-	IP44
EN Material	PE semi gloss, UV resistant	PE semi gloss, UV resistant
Colour	White, translucent	White, translucent
Lamp Holder	1x E27/ max. 40 W E27	1x E27/ max. 40 W E27
Illuminant	LED multicolour light bulb E27, max. 9 W, EEC: F, max. 850 lm, Life span: 50.000 h	LED bulb E27, max. 5,5 W, EEC: F, max. 500 lm Life span: 15.000 h
Remote Control	with Radio remote control	-
Rechargeable battery/ Charging Time Runtime (in colour change)	-	-
Charger	-	-
Cable	approx. 3 m with foot switch, clear	approx. 5 m, black
Voltage	230 V~, 50 Hz	230 V~, 50 Hz
Protection Class	II	II
For Indoor Use	Yes	-
For Outdoor Use	-	IP44
FR Matériaux	PE satiné, résistant aux rayons UV	PE satiné, résistant aux rayons UV
Couleur	Blanc, translucide	Blanc, translucide
Support de Lampe	1x E27/ max. 40 W E27	1x E27/ max. 40 W E27
Ampoule	LED multicolours E27, max. 9 W, CÉ: F, max. 850 lm, Durée de vie: 50.000 h	Illuminant à DEL E27, max. 5,5 W, CÉ: F, max. 500 lm Durée de vie: 15.000 h
Télécommande	avec télécommande radio	-
Batterie/ Temps de Charge Autonomie (en changement de couleur)	-	-
Chargeur	-	-
Câblage	env. 3 m avec pédale, transparent	env. 5 m, noir
Tension	230 V~, 50 Hz	230 V~, 50 Hz
Catégorie	II	II
Pour Utilisation Intérieure	Oui	-
Pour Utilisation Extérieure	-	IP44

BUBBLE OUTDOOR LED

15-02-01-LED



ca. | approx. | env. Ø 68 x H 41 cm

ca. | approx. | env. 8 kg

PE seidenmatt, UV-beständig
Weiß, transluzent
1x E27/ max. 40 W E27
Multicolor LED Leuchtmittel E27, max. 9 W, EEC: F, max. 850 lm
Lebensdauer: 50.000 h
mit Funkfernbedienung
-
-
ca. 5 m, schwarz
230 V~, 50 Hz
II
-
IP44

PE semi gloss, UV resistant
White, translucent
1x E27/ max. 40 W E27
LED multicolour light bulb E27, max. 9 W, EEC: F, max. 850 lm
Life span: 50.000 h
with Radio remote control
-
-
approx. 5 m, black
230 V~, 50Hz
II
-
IP44

PE satiné, résistant aux rayons UV
Blanc, translucide
1x E27/ max. 40 W E27
LED multicolours E27, max. 9 W, CÉ: F, max. 850 lm
Durée de vie: 50.000 h
avec télécommande radio
-
-
env. 5 m, noir
230 V~, 50Hz
II
-
IP44

BUBBLE LED ACCU OUTDOOR

15-04-02



ca. | approx. | env. Ø 68 x H 41 cm

ca. | approx. | env. 6 kg

PE seidenmatt, UV-beständig
weiß, transluzent
Eingebaute LED-Einheit (ausbaubar)
Multicolor & Warmweiß 2700 K, Kaltweiß 6000 K LEDs, max. 7.2 W, max. 810 lm, Lebensdauer: 30000 h
IR
3.7 V, 2 x 2600 mAh (Li-Ion)/ 10 h
11 h
100-240 V~, 50/60 Hz, Vout 5 V, 1,2 A
1,2 m
100-240 VAC, 50/ 60 Hz
III (Produkt), II (Ladegerät)
-
IP54

PE semi gloss, UV resistant
white, translucent
Built-in LED Unit (removable)
Multicolor & warm white 2700 K, cool white 6000 K LEDs, max. 7.2 W, max. 810 lm, life span: 30000 h
IR
3.7 V, 2 x 2600 mAh (Li-Ion)/ 10 h
11 h
100-240 V~, 50/60 Hz, Vout 5 V, 1,2 A
1,2 m
100-240 VAC, 50/ 60 Hz
III (Product), II (Charger)
-
IP54

PE satiné, résistant aux rayons UV
blanc, translucide
Unité à LED intégrée (amovible)
DEL multicolores & blanc chaud 2700 K, blanc froid 6000 K, max. 7,2 W, max. 810 lm, durée de vie: 30000 h
IR
3.7 V, 2 x 2600 mAh (Li-Ion)/ 10 h
11 h
100-240 V~, 50/60 Hz, Vout 5 V, 1,2 A
1,2 m
100-240 VAC, 50/ 60 Hz
III (Produit), II (Chargeur)
-
IP54

BUBBLE CUSHIONS & GLASSTOP



Modell	15-11-01 Sitzkissen Orange
	15-12-01 Sitzkissen Rot
	15-13-01 Sitzkissen Violett
	15-14-01 Sitzkissen Grün
	15-15-01 Sitzkissen Anthrazit

Material	Filz, 100% Wolle
Maße	Ø 40 x H 5 cm
Gewicht	ca. 0.2 kg

Modell	15-10-01 Glastischplatte
Material	Sicherheitsglas, klar
Maße	Ø 40 x H 5 cm
Gewicht	1,5 kg

Model	15-11-01 Orange cushion
	15-12-01 Red cushion
	15-13-01 Purple cushion
	15-14-01 Green cushion
	15-15-01 Anthracite cushion

Material	Felt, 100% wool
Dims	Ø 40 x H 5 cm
Weight	approx. 0.2 kg

Model	15-10-01 Glasstop
Material	Safety glass, transparent
Dims	Ø 40 x H 5 cm
Weight	1.5 kg

Modèle	15-11-01 Orange coussin
	15-12-01 Rouge coussin
	15-13-01 Pourpre coussin
	15-14-01 Vert coussin
	15-15-01 Anthracite coussin

Matériaux	Feutre, 100% laine
Dims	Ø 40 x H 5 cm
Poids	env. 0.2 kg

Modèle	15-10-01 Panneau de verre
Matériaux	Verre de sécurité, transparent
Dims	Ø 40 x H 5 cm
Poids	1,5 kg

CUBE

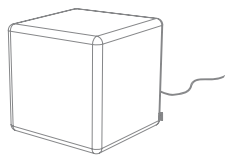

Zubehör: Glasplatte oder Sitzkissen
 Accessory: Glass top or cushion
 Accessoire: Plaque de verre ou coussin

CUBE INDOOR

06-05-01

CUBE INDOOR LED

06-05-01-LED

Modell | Model | Modèle

	  	    
Maße Dimensions Dimensions	ca. approx. env. 44 x 44 x 45 cm	ca. approx. env. 44 x 44 x 45 cm
Gewicht Weight Poids	ca. approx. env. 6 kg	ca. approx. env. 6 kg
DE Material	PE seidenmatt, UV-beständig	PE seidenmatt, UV-beständig
Farbe	Weiß, transluzent	Weiß, transluzent
Lampenfassung	1x E27/ max. 40 W E27	1x E27/ max. 40 W E27
Leuchtmittel	LED Leuchtmittel E27, max. 5,5 W, EEC: F, max. 500 lm Lebensdauer: 15.000 h	Multicolor LED Leuchtmittel E27, max. 9 W, EEC: F, max. 850 lm Lebensdauer: 50.000 h
Fernbedienung	-	mit Funkfernbedienung
Aufladbarer Akku/ Ladezeit Laufzeit (in Farbwechsel)	-	-
Ladegerät	-	-
Verkabelung	ca. 3 m mit Fußschalter, klar	ca. 3 m mit Fußschalter, klar
Spannung	230 V~, 50Hz	230 V~, 50Hz
Schutzklasse	II	II
Für Innenbereich	Ja	Ja
Für Aussenbereich	-	-
EN Material	PE semi gloss, UV resistant	PE semi gloss, UV resistant
Colour	White, translucent	White, translucent
Lamp Holder	1x E27/ max. 40 W E27	1x E27/ max. 40 W E27
Illuminant	LED bulb E27, max. 5,5 W, EEC: F, max. 500 lm Life span: 15.000 h	LED multicolour light bulb E27, max. 9 W, EEC: F, max. 850 lm, Life span: 50.000 h
Remote Control	-	with Radio remote control
Rechargeable battery/ Charging Time Runtime (in colour change)	-	-
Charger	-	-
Cable	approx. 3 m with foot switch, clear	approx. 3 m with foot switch, clear
Voltage	230 V~, 50 Hz	230 V~, 50Hz
Protection Class	II	II
For Indoor Use	Yes	Yes
For Outdoor Use	-	-
FR Matériaux	PE satiné, résistant aux rayons UV	PE satiné, résistant aux rayons UV
Couleur	Blanc, translucide	Blanc, translucide
Support de Lampe	1x E27/ max. 40 W E27	1x E27/ max. 40 W E27
Ampoule	Illuminant à DEL E27, max. 5,5 W, CÉ: F, max. 500 lm Durée de vie: 15.000 h	LED multicolours E27, max. 9 W, CÉ: F, max. 850 lm, Durée de vie: 50.000 h
Télécommande	-	avec télécommande radio
Batterie/ Temps de Charge Autonomie (en changement de couleur)	-	-
Chargeur	-	-
Câblage	env. 3 m avec pédale, transparent	env. 3 m avec pédale, transparent
Tension	230 V~, 50 Hz	230 V~, 50Hz
Catégorie	II	II
Pour Utilisation Intérieure	Oui	Oui
Pour Utilisation Extérieure	-	-

CUBE OUTDOOR

06-06-01

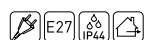

ca. | approx. | env. 44 x 44 x 45 cm

ca. | approx. | env. 6.5 kg

PE seidenmatt, UV-beständig
Weiß, transluzent
1x E27/ max. 40 W E27
LED Leuchtmittel E27, max. 5,5 W, EEC: F, max. 500 lm Lebensdauer: 15.000 h
-
-
-
ca. 5 m, schwarz
230 V~, 50 Hz
II
-
IP44

PE semi gloss, UV resistant
White, translucent
1x E27/ max. 40 W E27
LED bulb E27, max. 5,5 W, EEC: F, max. 500 lm Life span: 15.000 h
-
-
-
approx. 5 m, black
230 V~, 50 Hz
II
-
IP44

PE satiné, résistant aux rayons UV
Blanc, translucide
1x E27/ max. 40 W E27
illuminant à DEL E27, max. 5,5 W, CE: F, max. 500 lm Durée de vie: 15.000 h
-
-
-
env. 5 m, noir
230 V~, 50 Hz
II
-
IP44

CUBE OUTDOOR LED

06-06-01-LED



ca. | approx. | env. 44 x 44 x 45 cm

ca. | approx. | env. 6.5 kg

PE seidenmatt, UV-beständig
Weiß, transluzent
1x E27/ max. 40 W E27
Multicolor LED Leuchtmittel E27, max. 9 W, EEC: F, max. 850 lm Lebensdauer: 50.000 h mit Funkfernbedienung
-
-
-
ca. 5 m, schwarz
230 V~, 50 Hz
II
-
IP44

PE semi gloss, UV resistant
White, translucent
1x E27/ max. 40 W E27
LED multicolour light bulb E27, max. 9 W, EEC: F, max. 850 lm, Life span: 50.000 h with Radio remote control
-
-
-
approx. 5 m, black
230 V~, 50 Hz
II
-
IP44

PE satiné, résistant aux rayons UV
Blanc, translucide
1x E27/ max. 40 W E27
LED multicolours E27, max. 9 W, CE: F, max. 850 lm, Durée de vie: 50.000 h avec télécommande radio
-
-
-
env. 5 m, noir
230 V~, 50 Hz
II
-
IP44

CUBE LED ACCU OUTDOOR

09-01-04



ca. | approx. | env. 44 x 44 x 45 cm

ca. | approx. | env. 6 kg

PE seidenmatt, UV-beständig
Weiß, transluzent
Eingebaute LED-Einheit (ausbaubar)
Multicolor & Warmweiß 2700 K, Kaltweiß 6000 K LEDs, max. 7,2 W, max. 810 lm, Lebensdauer: 30000 h
IR
3,7 V, 2 x 2600 mAh (Li-Ion)/ 10 h 11 h
100-240 V~, 50/60 Hz, Vout 5 V, 1,2 A
1,2 m
100-240 VAC, 50/ 60 Hz
III (Produkt), II (Ladegerät)
-
IP54

PE semi gloss, UV resistant
White, translucent
Built-In LED Unit (removable)
Multicolor & warm white 2700 K, cool white 6000 K LEDs, max. 7,2 W, max. 810 lm, life span: 30000 h
IR
3,7 V, 2 x 2600 mAh (Li-Ion)/ 10 h 11 h
100-240 V~, 50/60 Hz, Vout 5 V, 1,2 A
1,2 m
100-240 VAC, 50/ 60 Hz
III (Product), II (Charger)
-
IP54

PE satiné, résistant aux rayons UV
Blanc, translucide
Unité à LED intégrée (amovible)
DEL multicolores & blanc chaud 2700 K, blanc froid 6000 K, max. 7,2 W, max. 810 lm, durée de vie: 30000 h
IR
3,7 V, 2 x 2600 mAh (Li-Ion)/ 10 h 11 h
100-240 V~, 50/60 Hz, Vout 5 V, 1,2 A
1,2 m
100-240 VAC, 50/ 60 Hz
III (Produit), II (Chargeur)
-
IP54

CUBE CUSHIONS & GLASSTOP



Modell	06-09-06 Sitzkissen Orange
	06-09-05 Sitzkissen Rot
	06-09-04 Sitzkissen Violett
	06-09-03 Sitzkissen Grün
	06-09-02 Sitzkissen Anthrazit

Material	Filz, 100% Wolle
Maße	B 40 x L 40 x H 0,5 cm
Gewicht	ca. 0.2 kg

Modell	06-09-01 Glastischplatte
Material	Sicherheitsglas, klar
Maße	B 40 x L 40 x H 0,5 cm
Gewicht	2,2 kg

Model	06-09-06 Orange cushion
	06-09-05 Red cushion
	06-09-04 Purple cushion
	06-09-03 Green cushion
	06-09-02 Anthracite cushion

Material	Felt, 100% wool
Dims	L 40 x W 40 x H 0.5 cm
Weight	approx. 0.2 kg

Model	06-09-01 Glasstop
Material	Safety glass, transparent
Dims	L 40 x W 40 x H 0.5 cm
Weight	2,2 kg

Modèle	06-09-06 Orange coussin
	06-09-05 Rouge coussin
	06-09-04 Pourpre coussin
	06-09-03 Vert coussin
	06-09-02 Anthracite coussin

Matériaux	Feutre, 100% laine
Dims	Lo 40 x La 40 x H 0.5 cm
Poids	env. 0.2 kg

Modèle	06-09-01 Panneau de verre
Matériaux	Verre de sécurité, transparent
Dims	Lo 40 x La 40 x H 0.5 cm
Poids	2,2 kg

LEUCHTEN - TECHNISCHE DATEN

LIGHTING TECHNICAL DATA | LUMIÈRES CARACTÉRISTIQUES TECHNIQUES



EMILY

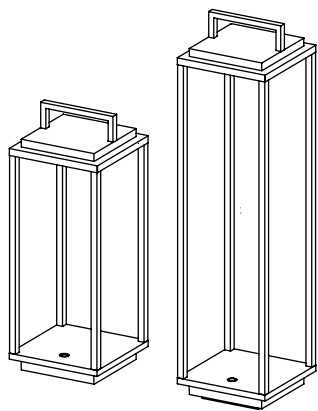

Ladestation
Charging Station
Station de chargement

Modell | Model | Modèle

EMILY M

46-01-38



DE	Material	Aluminium	Aluminium
	Farbe	Anthrazit (matt)	Anthrazit (matt)
	Maße	B14 x T14 x H38 cm	B14 x T14 x H54 cm
	Gewicht	1,5 Kg	1,5 Kg
	LED-Einheit	Fest eingebaut	Fest eingebaut
	Leuchtmittel/lm/Kelvin/Watt	LEDs (dimmbar)/ 180 lm/ 3000K, warmweiß/ max. 2,2 W	LEDs (dimmbar)/ 180 lm/ 3000K, warmweiß/ max. 2,2 W
	Aufladbarer Akku	DC 3.7 V, 2 x 2200 mAh (Li-Ion), austauschbar	DC 3.7 V, 2 x 2200 mAh (Li-Ion), austauschbar
	Ladezeit	Ca. 8 h	Ca. 8 h
	Laufzeit	Ca. 11 h (bei 100% LED-Helligkeit), bei gedimmtem Licht länger	Ca. 11 h (bei 100% LED-Helligkeit), bei gedimmtem Licht länger
	Ladegerät	Vout 5 V / 1 A	Vout 5 V / 1 A
	Kabel Ladestation	1,2 m, weiss	1,2 m, weiss
	Schutzklasse	III (Leuchte), II (Ladegerät)	III (Leuchte), II (Ladegerät)
	Für Innenbereich	Ladegerät	Ladegerät
	Für Aussenbereich	IP54 (Leuchte)	IP54 (Leuchte)

EN	Material	Aluminium	Aluminium
	Colour	Matte anthracite	Matte anthracite
	Dimensions	W14 x D14 x H38 cm	W14 x D14 x H54 cm
	Weight	1.5 Kg	1.5 Kg
	LED Unit	Permanently installed	Permanently installed
	Illuminant	LEDs (dimmbable)/ 180 lm/ 3000K, warmwhite/ max. 2.2 W	LEDs (dimmbable)/ 180 lm/ 3000K, warmwhite/ max. 2.2 W
	Rechargeable battery	DC 3.7 V, 2 x 2200 mAh (Li-Ion)	DC 3.7 V, 2 x 2200 mAh (Li-Ion)
	Charging time	8 h	8 h
	Runtime	Approx. 11 h (at 100% LED brightness), with dimmed light longer	Approx. 11 h (at 100% LED brightness), with dimmed light longer
	Adapter	Vout 5 V / 1 A	Vout 5 V / 1 A
	Cable Charging Station	1.2 m, white	1.2 m, white
	Protection Class	III (Lamp), II (Adapter)	III (Lamp), II (Adapter)
	For Indoor Use	Adapter	Adapter
	For Outdoor Use	IP54 (Lamp)	IP54 (Lamp)

FR	Matériaux	Aluminium	Aluminium
	Couleur	Anthracite mat	Anthracite mat
	Dimensions	L14 x L14 x H38 cm	L14 x L14 x H54 cm
	Poids	1.5 kg	1.5 kg
	Unité DEL	Fixé en permanence	Fixé en permanence
	Ampoule	LEDs (dimmbable)/ 180 lm/ 3000K, blanc chaud / max. 2,2 W	LEDs (dimmbable)/ 180 lm/ 3000K, blanc chaud / max. 2,2 W
	Batterie rechargeable	DC 3.7 V, 2 x 2200 mAh (Li-Ion)	DC 3.7 V, 2 x 2200 mAh (Li-Ion)
	Temps de charge	8 h	8 h
	Durée	Env. 11 h (à 100% de luminosité), plus longtemps si la lumière est baissée	Env. 11 h (à 100% de luminosité), plus longtemps si la lumière est baissée
	Chargeur	Vout 5 V / 1 A	Vout 5 V / 1 A
	Station de recharge	1,2 m, blanc	1,2 m, blanc
	Catégorie	III (Lampe), II (Adaptateur)	III (Lampe), II (Adaptateur)
	Pour Utilisation Intérieur	Chargeur	Chargeur
	Pour Utilisation Extérieure	IP54 (Lampe)	IP54 (Lampe)

SPOT.E

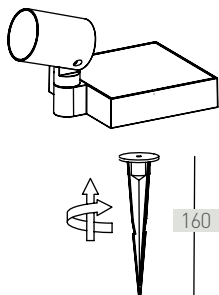

SPOT.E

43-01-01

Modell | Model | Modèle



DE	Material	Aluminium
	Farbe	Anthrazit
	Maße	B225 x T140 x H115 mm
	Gewicht	1 kg
	LED-Einheit	Fest verbaut
	Leuchtmittel/ lm/ Kelvin/ Watt	LEDs / 110 lm/ 3000K, warmweiß/ max. 1,3 W
	Aufladbarer Akku	DC 3.7 V, 1 x 2200 mAh (Li-Ion)
	Ladezeit bei Sonnenschein	Ca. 8 Std
	Laufzeit	Ca. 7 Std
	Solarpanel	2 W
	Ein/Aus Schalter	Beleuchtet
	Helligkeitssensor	Automatisches Ein-/Ausschalten durch Helligkeitssensor bei 20-30 Lux
	Schutzklasse	III
	Für Aussenbereich	IP65

EN	Material	Aluminium
	Colour	Matte anthracite
	Dimensions	W225 x D140 x H115 mm
	Weight	1 Kg
	LED Unit	Permanently installed
	Illuminant	LEDs / 110lm/ 3000K, warmwhite/ max. 1.3 W
	Rechargeable battery	DC 3.7 V, 1 x 2200 mAh (Li-Ion)
	Charging Time Solar	Approx 8 h
	Runtime	Approx. 7 h
	Solar Panel	2 W
	ON/OFF Switch	Illuminated
	Brightness Sensor	Automatic ON/OFF at 20-30 lux
	Protection Class	III (Lamp)
	For Outdoor Use	IP65 (Lamp)

FR	Matériaux	Aluminium
	Couleur	Anthracite
	Dimensions	L225 x P140 x H115 mm
	Poids	1 kg
	Unité à LED	Fixé en permanence
	Ampoule	LEDs (dimmable)/ 110 lm/ 3000K, blanc chaud / max. 1,3 W
	Batterie rechargeable	DC 3.7 V, 1 x 2200 mAh (Li-Ion)
	Temps de charge soleil	Env. 8 heures
	Durée	Env. 7 heures
	Panneau Solaire	2 W
	Interrupteur marche/arrêt	éclairé
	Mise en marche/arrêt	automatique par capteur de luminosité à 20-30 lux
	Catégorie	III (Lanterne)
	Pour Utilisation Extérieure	IP65 (Lanterne)

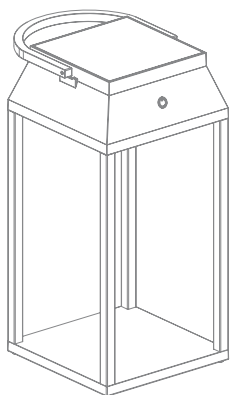

Modell Model Modèle	LOUIS (WHITE) 38-01-36	LOUIS (ANTHRACITE) 38-02-36
DE		
Material	Aluminium	Aluminium
Farbe	Mattweiß	Anthrazit (matt)
Maße	B17,5 x T17,5 x H36 cm (mit Griff vertikal H 49 cm) (mit Griff horizontal B 22,3 cm)	B17,5 x T17,5 x H36 cm (mit Griff vertikal H 49 cm) (mit Griff horizontal B 22,3 cm)
Gewicht	ca. 1,6 kg	ca. 1,6 kg
Lampenfassung	EINGEBAUTE LED-Einheit (ausbaubar)	EINGEBAUTE LED-Einheit (ausbaubar)
Leuchtmittel/ lm/ Kelvin/ Watt	LEDs (dimmbar)/ 238 lm/ 3000K, warmweiß/ max. 3 W	LEDs (dimmbar)/ 238 lm/ 3000K, warmweiß/ max. 3 W
Aufladbarer Akku	DC 3.7 V, 2 x 2200 mAh (Li-Ion)	DC 3.7 V, 2 x 2200 mAh (Li-Ion)
Ladezeit mit Ladegerät/ Sonnenschein Laufzeit	Ladegerät 5-7/ Sonne ca.16-17 Std. Ca. 9 Std. (100% Helligkeit)	Ladegerät 5-7/ Sonne ca.16-17 Std. Ca. 9 Std. (100% Helligkeit)
Ladegerät	Vout 5 V / 1 A	Vout 5 V / 1 A
Verkabelung	1,8 m, weiss	1,8 m, weiss
Schutzklasse	III (Laterne), II (Ladegerät)	III (Laterne), II (Ladegerät)
Für Innenbereich	Ladegerät	Ladegerät
Für Aussenbereich	IP54 (Laterne)	IP54 (Laterne)
EN		
Material	Aluminium	Aluminium
Colour	Matte white	Matte anthracite
Dimensions	W17,5 x D17,5 x H36 cm (with vertical handle H49 cm) (with horizontal handle W22.3 cm)	W17,5 x D17,5 x H36 cm (with vertical handle H49 cm) (with horizontal handle W22.3 cm)
Weight	1.6 kg	1.6 kg
Lamp Holder	Built-In LED Unit (removable)	Built-In LED Unit (removable)
Illuminant	LEDs (dimmbable)/ 238 lm/ 3000K, warmwhite/ max. 3 W	LEDs (dimmbable)/ 238 lm/ 3000K, warmwhite/ max. 3 W
Rechargeable battery	DC 3.7 V, 2 x 2200 mAh (Li-Ion)	DC 3.7 V, 2 x 2200 mAh (Li-Ion)
Charging time adapter/ Solar Runtime	USB 5-7 h, Sunshine 16-17 h 12 h approx. 9 h (100% brightness)	USB 5-7 h, Sunshine 16-17 h 12 h approx. 9 h (100% brightness)
Adapter	Vout 5 V / 1 A	Vout 5 V / 1 A
Cable	1.8 m, white	1.8 m, white
Protection Class	III (Product), II (Charger)	III (Product), II (Charger)
For Indoor Use	Adapter	Adapter
For Outdoor Use	IP54 (Lantern)	IP54 (Lantern)
FR		
Matériaux	Aluminium	Aluminium
Couleur	Blanc mat	Anthracite mat
Dimensions	L17,5 x P17,5 x H36 cm (avec poignée verticale H 49 cm) (avec poignée horizontale L 22,3 cm)	L17,5 x P17,5 x H36 cm (avec poignée verticale H 49 cm) (avec poignée horizontale L 22,3 cm)
Poids	env. 1,6 kg	env. 1,6 kg
Support de Lampe	Unité à LED intégrée (amovible)	Unité à LED intégrée (amovible)
Ampoule	LEDs (dimmbable)/ 238 lm/ 3000K, blanc chaud / max. 3 W	LEDs (dimmbable)/ 238 lm/ 3000K, blanc chaud / max. 3 W
Batterie rechargeable	DC 3.7 V, 2 x 2200 mAh (Li-Ion)	DC 3.7 V, 2 x 2200 mAh (Li-Ion)
Temps de charge avec chargeur/ soleil Durée	Chargeur 5-7 / soleil env. 16-17 heures Env. 9 heures (luminosité 100%)	Chargeur 5-7 / soleil env. 16-17 heures Env. 9 heures (luminosité 100%)
Chargeur	Vout 5 V / 1 A	Vout 5 V / 1 A
Câblage	1,8 m, blanc	1,8 m, blanc
Catégorie	III (lanterne), II (chargeur)	III (lanterne), II (chargeur)
Pour Utilisation Intérieur	Chargeur	Chargeur
Pour Utilisation Extérieure	IP54 (Lanterne)	IP54 (Lanterne)

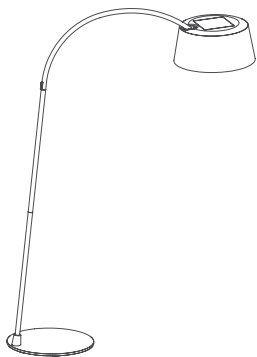
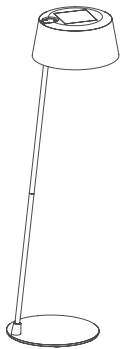

Modell | Model | Modèle

ISA-BELLE

44-01-01



DE	Material	Stahl/Kunststoff
	Farbe	Grau
	Maße Stehleuchte	B145 x T48 x H190 cm
	Maße Bogenleuchte	B58 x T48 x H172 cm
	Gewicht Stehleuchte/Bogenleuchte	20 kg / 20 kg
	LED-Einheit	ausbaubar
	Leuchtmittel/lm/Kelvin/Watt	LEDs (Dimmbar 20-35-70-100%)/ 800 lm/3000K, warmweiß/max. 6 W
	Aufladbarer Akku	DC 3.7 V, 3 x 2200 mAh (Li-Ion)
	Ladezeit mit Ladegerät/Sonnenschein	Ladegerät ca. 10 Std/ Sonne 16 Std
	Laufzeit	Ca. 8-20 Std (20-100% Helligkeit)
	Ladegerät/Solarpanel	Vout 5 V, 1 A / 3 W
	Verkabelung	2,5 m, weiss
	Schutzklasse	III (Leuchte), II (Ladegerät)
	Für Innenbereich	Ladegerät
	Für Aussenbereich	IP54 (Leuchte)

EN	Material	Steel/plastic
	Colour	Grey
	Dimensions	W145 x D48 x H190 cm W58 x D48 x H172 cm
	Weight	20 kg / 20 kg
	LED-Unit	Removable
	Illuminant	LEDs (dimmable 20-35-70-100%)/ 800 lm/3000K, warmwhite/max. 6 W
	Rechargeable battery	DC 3.7 V, 3 x 2200 mAh (Li-Ion)
	Charging time adapter/ Sunshine	Adapter approx. 10 h/ Sunshine 16 h
	Runtime	Approx. 8-20 Std (20-100% brightness)
	Adapter/Solar panel	Vout 5 V, 1 A / 3 W
	Cable	2.5 m, white
	Protection Class	III (Luminaire), II (Adapter)
	For Indoor Use	Adapter
	For Outdoor Use	IP54 (Luminaire)

FR	Matériaux	Acier/plastique
	Couleur	Blanc mat
	Dimensions	L145 x L48 x H190 cm L58 x L48 x H172 cm
	Poids	20 kg / 20 kg
	Unité DEL	Démontable
	Ampoule	LEDs (dimmable 20-35-70-100%)/ 800 lm/3000K, blanc chaud/max. 6 W
	Batterie rechargeable	DC 3.7 V, 3 x 2200 mAh (Li-Ion)
	Temps de charge avec chargeur/soleil	Chargeur env. 10 h/ soleil 16 h
	Durée	Env. 8-20 h (20-100% luminosité)
	Chargeur/Panneau solaire	Vout 5 V, 1 A / 3 W
	Câblage	2,5 m, blanc
	Catégorie	III (Luminaire), II (chargeur)
	Pour Utilisation Intérieure	Chargeur
	Pour Utilisation Extérieure	IP54 (Luminaire)

SWAP 150

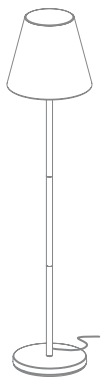

SWAP ist auch mit mehrfarbigem/weißem Leuchtmittel erhältlich, siehe RGB-Leuchtmittel Mod. 20-02-01 oder Mod. 20-03-01

SWAP is also available with multicolor/white bulb, refer to RGB bulb Mod. 20-02-01 or Mod. 20-03-01

SWAP est également disponible avec la lumière multicolore/ blanche, référez-vous à Ampoule RGB Mod. 20-02-01 ou Mod. 20-03-01

Modell | Model | Modèle

SWAP OUTDOOR

31-0X-150



DE	Material	PE transluzent, Metallgestell
	Farbe	Mattweiß
	Maße	ca. Ø 35 cm, H 150 cm
	Gewicht	ca. 7 kg
	Lampenfassung	1x E27/max. 40 W E27
	Leuchtmittel	E27
	Fernbedienung	-
	Ladegerät	-
	Verkabelung	Ca. 3 m, schwarz
	Spannung	230 V~, 50 Hz
	Schutzklasse	II
	Für Aussenbereich	IP44

EN	Material	PE translucent shade, metal stand
	Colour	White matte
	Dimensions	approx. Ø 35 cm, H 150 cm
	Weight	approx. 7 kg
	Lamp Holder	1x E27/max. 40 W E27
	Illuminant	E27
	Remote Control	-
	Charger	-
	Cable	Approx. 3 m, black
	Voltage	230 V~, 50 Hz
	Protection Class	II
	For Outdoor Use	IP44

FR	Matériaux	PE translucide, support en métal
	Couleur	Blanc satiné
	Dimensions	Env. Ø 35 cm, H 150 cm
	Poids	Env. 7 kg
	Support de Lampe	1x E27/max. 40 W E27
	Ampoule	E27
	Télécommande	-
	Chargeur	-
	Câblage	Env. 3 m, noir
	Tension	230 V~, 50 Hz
	Catégorie	II
	Pour Utilisation Extérieure	IP44

SWAP SHADES



Modell	31-01-01 Blaue Linien
	31-02-01 Grüner Dschungel
	31-03-01 Grau Quatrefoil
	31-04-01 Rosa Chevron
	31-05-01 Silberne Sterne
	31-06-01 Kunststoffgewebe, grau
Material	PE
Maße	Ø 34,5 x H 29 cm
Gewicht	0.12 kg

Model	31-01-01 Royal blue lines
	31-02-01 Hunter green jungle
	31-03-01 Cool grey quatrefoil
	31-04-01 Rose pink chevron
	31-05-01 Stars on silver
	31-06-01 Grey coated fabric
Material	PE
Dims.	Ø 34.5 x H 29 cm
Weight	0.12 kg

Modèle	31-01-01 Lignes bleues
	31-02-01 Jungle verte
	31-03-01 Gris quatrefoil
	31-04-01 Rose chevron
	31-05-01 Étoiles d'argent
	31-06-01 Tissu en plastique gris
Matériaux	PE
Dims.	Ø 34,5 x H 29 cm
Poids	0.12 kg

SWAP 150 & SHADES

SWAP + ROYAL BLUE LINES
31-01-150

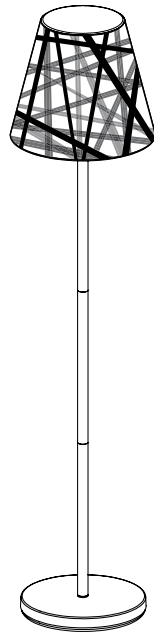

SWAP + HUNTER GREEN JUNGLE
31-02-150

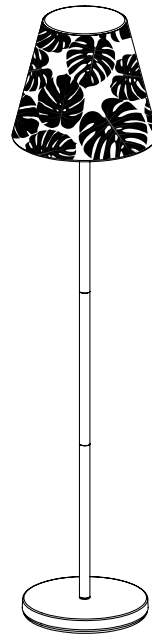

SWAP + COOL GREY QUATREFOIL
31-03-150

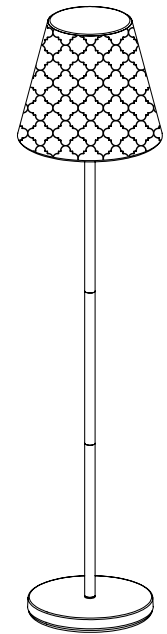

ROYAL BLUE LINES
31-01-01

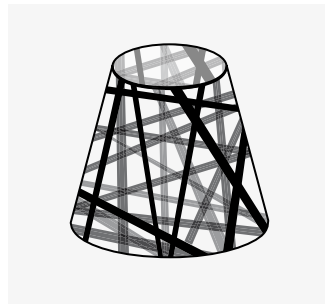

HUNTER GREEN JUNGLE
31-02-01



COOL GREY QUATREFOIL
31-03-01

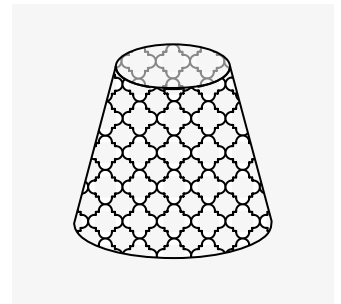

SWAP + ROSE PINK CHEVRON
31-04-150

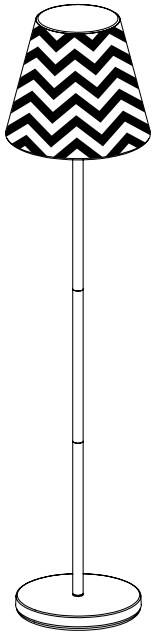

SWAP + SILVER STARS
31-05-150

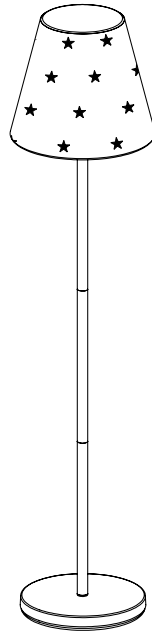

SWAP + GREY COATED FABRIC
31-06-150

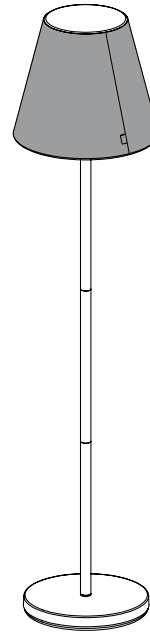

SWAP
31-00-150

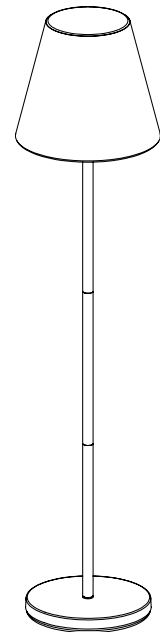

Leuchte ohne Design-Lampenschirm
Lamp without design shade cover
Lampe sans abat-jour

ROSE PINK CHEVRON
31-04-01



SILVER STARS
31-05-01

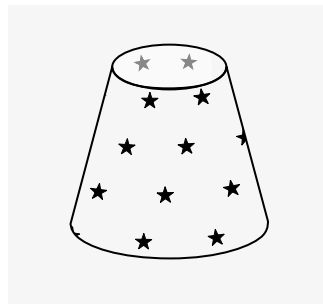

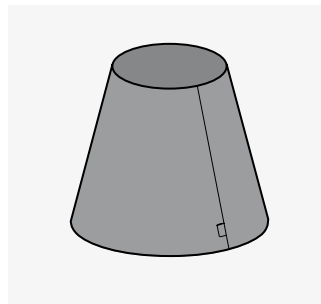

GREY COATED FABRIC
31-06-01



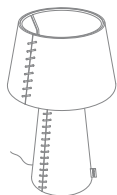

ALICE



	ALICE 29-01-01	ALICE LED 29-01-01-LED
Modell Model Modèle	29-01-01	29-01-01-LED
	 E27 	 E27    
DE Material	Filz (PE)	Filz (PE)
Farbe	Grau	Grau
Maße	Ø 30 cm, H 50 cm	Ø 30 cm, H 50 cm
Maße Schirm	Ø 30 cm, H 18 cm	Ø 30 cm, H 18 cm
Gewicht	1,8 Kg	1,8 Kg
Lampenfassung	1x E27/ max. 40 W E27	1x E27/ max. 40 W E27
Leuchtmittel	LED Leuchtmittel E27, max. 5,5 W, EEC: F, max. 500 lm Lebensdauer: 15.000 h	Multicolor LED Leuchtmittel E27, max. 9 W, EEC: F, max. 850 lm Lebensdauer: 50.000 h
Fernbedienung	-	mit Funkfernbedienung
Aufladbarer Akku/ Ladezeit Laufzeit (in Farbwechsel)	-	-
Ladegerät	-	-
Verkabelung	1,3 m, transluzent	1,3 m, transluzent
Spannung	230 V~, 50 Hz	230 V~, 50 Hz
Schutzklasse	II	II
Für Innenbereich	Ja	Ja
EN Material	Felt (PE)	Felt (PE)
Colour	Grey	Grey
Dimensions	Ø 30 cm, H 50 cm	Ø 30 cm, H 50 cm
Dimensions Shade	Ø 30 cm, H 18 cm	Ø 30 cm, H 18 cm
Weight	1,8 Kg	1,8 Kg
Lamp Holder	1x E27/ max. 40 W E27	1x E27/ max. 40 W E27
Illuminant	LED bulb E27, max. 5,5 W, EEC: F, max. 500 lm Life span: 15.000 h	LED multicolour light bulb E27, max. 9 W, EEC: F, max. 850 lm, Life span: 50.000 h
Remote Control	-	with Radio remote control
Rechargeable battery/ Charging Time Runtime (in colour change)	-	-
Charger	-	-
Cable	1,3 m, translucent	1,3 m, translucent
Voltage	230 V~, 50 Hz	230 V~, 50 Hz
Protection Class	II	II
For Indoor Use	Yes	Yes
FR Matériaux	Feutre (PE)	Feutre (PE)
Couleur	Gris	Gris
Dimensions	Ø 30 cm, H 50 cm	Ø 30 cm, H 50 cm
Abat-Jour	Ø 30 cm, H 18 cm	Ø 30 cm, H 18 cm
Poids	1,8 Kg	1,8 Kg
Support de Lampe	1x E27/ max. 40 W E27	1x E27/ max. 40 W E27
Ampoule	Illuminant à DEL E27, max. 5,5 W, CÉ: F, max. 500 lm Durée de vie: 15.000 h	LED multicolours E27, max. 9 W, CÉ: F, max. 850 lm, Durée de vie: 50.000 h
Télécommande	-	avec télécommande radio
Batterie/ Temps de Charge Autonomie (en changement de couleur)	-	-
Chargeur	-	-
Câblage	1,3 m, transparent	1,3 m, transparent
Tension	230 V~, 50 Hz	230 V~, 50 Hz
Catégorie	II	II
Pour Utilisation Intérieur	Oui	Oui

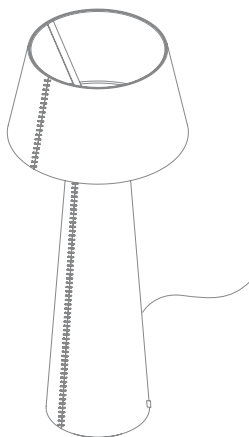

ALICE XL



	ALICE XL 29-02-01	ALICE XL LED 29-02-01- LED
Modell Model Modèle	29-02-01	29-02-01- LED
	  	    
DE		
Material	Filz (PE)	Filz (PE)
Farbe	Grau	Grau
Maße	Ø 70 cm, H 172 cm	Ø 70 cm, H 172 cm
Maße Schirm	Ø 70 cm, H 40 cm	Ø 70 cm, H 40 cm
Gewicht	15,8 Kg	15,8 Kg
Lampenfassung	1x E27/ max. 40 W E27	1x E27/ max. 40 W E27
Leuchtmittel	LED Leuchtmittel E27, max. 5,5 W, EEK: F, max. 500 lm Lebensdauer: 15.000 h	Multicolor LED Leuchtmittel E27, max. 9 W, EEK: F, max. 850 lm Lebensdauer: 50.000 h
Fernbedienung	-	mit Funkfernbedienung
Aufladbarer Akku/ Ladezeit	-	-
Laufzeit (in Farbwechsel)	-	-
Ladegerät	-	-
Verkabelung	2,2 m, transluzent	2,2 m, transluzent
Spannung	230 V~, 50 Hz	230 V~, 50 Hz
Schutzklasse	II	II
Für Innenbereich	Ja	Ja
EN		
Material	Felt (PE)	Felt (PE)
Colour	Grey	Grey
Dimensions	Ø 70 cm, H 172 cm	Ø 70 cm, H 172 cm
Dimensions Shade	Ø 70 cm, H 40 cm	Ø 70 cm, H 40 cm
Weight	15.8 Kg	15.8 Kg
Lamp Holder	1x E27/ max. 40 W E27	1x E27/ max. 40 W E27
Illuminant	LED bulb E27, max. 5,5 W, EEC: F, max. 500 lm Life span: 15.000 h	LED multicolour light bulb E27, max. 9 W, EEC: F, max. 850 lm, Life span: 50.000 h
Remote Control	-	with Radio remote control
Recharable battery/ Charging Time	-	-
Runtime (in colour change)	-	-
Charger	-	-
Cable	2.2 m, translucent	2.2 m, translucent
Voltage	230 V~, 50 Hz	230 V~, 50 Hz
Protection Class	II	II
For Indoor Use	Yes	Yes
FR		
Matériaux	Feutre (PE)	Feutre (PE)
Couleur	Gris	Gris
Dimensions	Ø 70 cm, H 172 cm	Ø 70 cm, H 172 cm
Abat-Jour	Ø 70 cm, H 40 cm	Ø 70 cm, H 40 cm
Poids	15,8 Kg	15,8 Kg
Support de Lampe	1x E27/ max. 40 W E27	1x E27/ max. 40 W E27
Ampoule	illuminant à DEL E27, max. 5,5 W, CE: F, max. 500 lm Durée de vie: 15.000 h	LED multicolours E27, max. 9 W, CE: F, max. 850 lm, Durée de vie: 50.000 h
Télécommande	-	avec télécommande radio
Batterie/ Temps de Charge	-	-
Autonomie (en changement de couleur)	-	-
Chargeur	-	-
Câblage	2,2 m, transparent	2,2 m, transparent
Tension	230 V~, 50 Hz	230 V~, 50 Hz
Catégorie	II	II
Pour Utilisation Intérieur	Oui	Oui

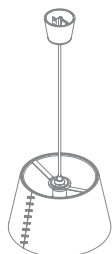



ALICE 30



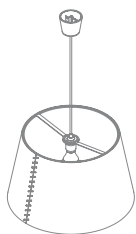





	ALICE 30 29-03-01	ALICE 30 LED 29-03-01-LED
Modell Model Modèle		
	 E27 	 E27  
DE Material	Filz (PE)	Filz (PE)
Farbe	Grau	Grau
Maße	Ø 30 cm, H 18 cm	Ø 30 cm, H 18 cm
Gewicht	0,7 Kg	0,7 Kg
Lampenfassung	1x E27/ max. 40 W E27	1x E27/ max. 40 W E27
Leuchtmittel	LED Leuchtmittel E27, max. 5,5 W, EEK: F, max. 500 lm Lebensdauer: 15.000 h	Multicolor LED Leuchtmittel E27, max. 9 W, EEK: F, max. 850 lm Lebensdauer: 50.000 h
Fernbedienung	-	mit Funkfernbedienung
Aufladbarer Akku/ Ladezeit	-	-
Laufzeit (in Farbwechsel)	-	-
Ladegerät	-	-
Verkabelung	1,8 m, rot textilmantelt	1,8 m, rot textilmantelt
Spannung	230 V~, 50 Hz	230 V~, 50 Hz
Schutzklasse	II	II
Für Innenbereich	Ja	Ja
EN Material	Felt (PE)	Felt (PE)
Colour	Grey	Grey
Dimensions	Ø 30 cm, H 18 cm	Ø 30 cm, H 18 cm
Weight	0,7 Kg	0,7 Kg
Lamp Holder	1x E27/ max. 40 W E27	1x E27/ max. 40 W E27
Illuminant	LED bulb E27, max. 5,5 W, EEC: F, max. 500 lm Life span: 15.000 h	LED multicolour light bulb E27, max. 9 W, EEC: F, max. 850 lm, Life span: 50.000 h
Remote Control	-	with Radio remote control
Rechargeable battery/ Charging Time	-	-
Runtime (in colour change)	-	-
Charger	-	-
Cable	1,8 m, red textile	1,8 m, red textile
Voltage	230 V~, 50 Hz	230 V~, 50 Hz
Protection Class	II	II
For Indoor Use	Yes	Yes
FR Matériaux	Feutre (PE)	Feutre (PE)
Couleur	Gris	Gris
Dimensions	Ø 30 cm, H 18 cm	Ø 30 cm, H 18 cm
Poids	0,7 Kg	0,7 Kg
Support de Lampe	1x E27/ max. 40 W E27	1x E27/ max. 40 W E27
Ampoule	Illuminant à DEL E27, max. 5,5 W, CÉ: F, max. 500 lm Durée de vie: 15.000 h	LED multicolours E27, max. 9 W, CÉ: F, max. 850 lm, Durée de vie: 50.000 h
Télécommande	-	avec télécommande radio
Batterie/ Temps de Charge	-	-
Autonomie (en changement de couleur)	-	-
Chargeur	-	-
Câblage	1,8 m, câble textile rouge	1,8 m, câble textile rouge
Tension	230 V~, 50 Hz	230 V~, 50 Hz
Catégorie	II	II
Pour Utilisation Intérieur	Oui	Oui

ALICE 50



Modell Model Modèle	ALICE 50 29-04-01	ALICE 50 LED 29-04-01- LED
	  	    
DE		
Material	Filz (PE)	Filz (PE)
Farbe	Grau	Grau
Maße	Ø 50 cm, H 30 cm	Ø 50 cm, H 30 cm
Gewicht	1,2 Kg	1,2 Kg
Lampenfassung	1x E27/ max. 40 W E27	1x E27/ max. 40 W E27
Leuchtmittel	LED Leuchtmittel E27, max. 5,5 W, EEK: F, max. 500 lm Lebensdauer: 15.000 h	Multicolor LED Leuchtmittel E27, max. 9 W, EEK: F, max. 850 lm Lebensdauer: 50.000 h
Fernbedienung	-	mit Funkfernbedienung
Aufladbarer Akku/ Ladezeit	-	-
Laufzeit (in Farbwechsel)	-	-
Ladegerät	-	-
Verkabelung	1,8 m, rot textilmantelt	1,8 m, rot textilmantelt
Spannung	230 V~, 50 Hz	230 V~, 50 Hz
Schutzklasse	II	II
Für Innenbereich	Ja	Ja
EN		
Material	Felt (PE)	Felt (PE)
Colour	Grey	Grey
Dimensions	Ø 50 cm, H 30 cm	Ø 50 cm, H 30 cm
Weight	1,2 Kg	1,2 Kg
Lamp Holder	1x E27/ max. 40 W E27	1x E27/ max. 40 W E27
Illuminant	LED bulb E27, max. 5,5 W, EEC: F, max. 500 lm Life span: 15.000 h	LED multicolour light bulb E27, max. 9 W, EEC: F, max. 850 lm, Life span: 50.000 h
Remote Control	-	with Radio remote control
Rechargeable battery/ Charging Time	-	-
Runtime (in colour change)	-	-
Charger	-	-
Cable	1,8 m, red textile	1,8 m, red textile
Voltage	230 V~, 50 Hz	230 V~, 50 Hz
Protection Class	II	II
For Indoor Use	Yes	Yes
FR		
Matériaux	Feutre (PE)	Feutre (PE)
Couleur	Gris	Gris
Dimensions	Ø 50 cm, H 30 cm	Ø 50 cm, H 30 cm
Poids	1,2 Kg	1,2 Kg
Support de Lampe	1x E27/ max. 40 W E27	1x E27/ max. 40 W E27
Ampoule	Illuminant à DEL E27, max. 5,5 W, CÉ: F, max. 500 lm Durée de vie: 15.000 h	LED multicolours E27, max. 9 W, CÉ: F, max. 850 lm, Durée de vie: 50.000 h
Télécommande	-	avec télécommande radio
Batterie/ Temps de Charge	-	-
Autonomie (en changement de couleur)	-	-
Chargeur	-	-
Câblage	1,8 m, câble textile rouge	1,8 m, câble textile rouge
Tension	230 V~, 50 Hz	230 V~, 50 Hz
Catégorie	II	II
Pour Utilisation Intérieur	Oui	Oui



	SHARK INDOOR 26-01-01	SHARK INDOOR LED 26-01-01-LED
Modell Model Modèle	26-01-01	26-01-01-LED
	  	    
Maße Dimensions Dimensions	ca. approx. env. 70 x 19.5 x 65 cm	ca. approx. env. 70 x 19.5 x 65 cm
Gewicht Weight Poids	ca. approx. env. 2.5 kg	ca. approx. env. 2.5 kg
DE Material	PE seidenmatt, UV-beständig	PE seidenmatt, UV-beständig
Farbe	Weiß, transluzent	Weiß, transluzent
Lampenfassung	1x E27/ max. 40 W E27	1x E27/ max. 40 W E27
Leuchtmittel	LED Leuchtmittel E27, max. 5,5 W, EEK: F, max. 500 lm Lebensdauer: 15.000 h	Multicolor LED Leuchtmittel E27, max. 9 W, EEK: F, max. 850 lm Lebensdauer: 50.000 h
Fernbedienung	-	mit Funkfernbedienung
Aufladbarer Akku/ Ladezeit Laufzeit (in Farbwechsel)	-	-
Ladegerät	-	-
Verkabelung	ca. 2,6 m mit Fußschalter, klar	ca. 2,6 m mit Fußschalter, klar
Spannung	230 V~, 50 Hz	230 V~, 50 Hz
Schutzklasse	II	II
Für Innenbereich	Ja	Ja
Für Aussenbereich	-	-
EN Material	PE semi gloss, UV resistant	PE semi gloss, UV resistant
Colour	White, translucent	White, translucent
Lamp Holder	1x E27/ max. 40 W E27	1x E27/ max. 40 W E27
Illuminant	LED bulb E27, max. 5,5 W, EEC: F, max. 500 lm Life span: 15.000 h	LED multicolour light bulb E27, max. 9 W, EEC: F, max. 850 lm, Life span: 50.000 h
Remote Control	-	with Radio remote control
Rechargeable battery/ Charging Time Runtime (in colour change)	-	-
Charger	-	-
Cable	approx. 2.6 m cable, clear	approx. 2.6 m cable, clear
Voltage	230 V~, 50 Hz	230 V~, 50 Hz
Protection Class	II	II
For Indoor Use	Yes	Yes
For Outdoor Use	-	-
FR Matériaux	PE satiné, résistant aux rayons UV	PE satiné, résistant aux rayons UV
Couleur	Blanc, translucide	Blanc, translucide
Support de Lampe	1x E27/ max. 40 W E27	1x E27/ max. 40 W E27
Ampoule	Illuminant à DEL E27, max. 5,5 W, CÉ: F, max. 500 lm Durée de vie: 15.000 h	LED multicolours E27, max. 9 W, CÉ: F, max. 850 lm, Durée de vie: 50.000 h
Télécommande	-	avec télécommande radio
Batterie/ Temps de Charge Autonomie (en changement de couleur)	-	-
Chargeur	-	-
Câblage	env. 2.6 m, transparent	env. 2.6 m, transparent
Tension	230 V~, 50 Hz	230 V~, 50 Hz
Catégorie	II	II
Pour Utilisation Intérieur	Oui	Oui
Pour Utilisation Extérieure	-	-

SHARK OUTDOOR

26-02-01

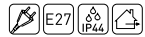

ca. | approx. | env. 70 x 19.5 x 65 cm

ca. | approx. | env. 3.2 kg

PE seidenmatt, UV-beständig

Weiß, transluzent

1x E27/ max. 40 W E27

LED Leuchtmittel E27,
max. 5,5 W, EEK: F, max. 500 lm
Lebensdauer: 15.000 h

-

-

-

ca. 4,6 m, schwarz

230 V~, 50 Hz

II

-

IP44

SHARK OUTDOOR LED

26-02-01-LED



ca. | approx. | env. 70 x 19.5 x 65 cm

ca. | approx. | env. 3.2 kg

PE seidenmatt, UV-beständig

Weiß, transluzent

1x E27/ max. 40 W E27

Multicolor LED Leuchtmittel E27,
max. 9 W, EEK: F, max. 850 lm
Lebensdauer: 50.000 h

mit Funkfernbedienung

-

-

ca. 4,6 m, schwarz

230 V~, 50 Hz

II

-

IP44

SHARK OUTDOOR LED ACCU

26-03-01



ca. | approx. | env. 70 x 19.5 x 65 cm

ca. | approx. | env. 2.5 kg

PE seidenmatt, UV-beständig

Weiß, transluzent

EINGEBAUTE LED-Einheit (ausbaubar)

Multicolor & Warmweiß 2700 K,
Kaltweiß 6000 K LEDs, max. 7,2 W,
max. 810 lm, Lebensdauer: 30000 h

IR

3.7 V, 2 x 2600 mAh (Li-Ion)/ 10 Std.
11 Std.

100-240 V~, 50/60 Hz, Vout 5 V, 1,2 A

1,2 m

100-240 VAC, 50/60 Hz

III (Produkt), II (Ladegerät)

-

IP54

PE semi gloss, UV resistant

White, translucent

1x E27/ max. 40 W E27

LED bulb E27,
max. 5,5 W, EEC: F, max. 500 lm
Life span: 15.000 h

-

-

-

approx. 4.6 m, black

230 V~, 50 Hz

II

-

IP 44

PE semi gloss, UV resistant

White, translucent

1x E27/ max. 40 W E27

LED multicolour light bulb E27,
max. 9 W, EEC: F, max. 850 lm,
Life span: 50.000 h

with Radio remote control

-

-

approx. 4.6 m, black

230 V~, 50 Hz

II

-

IP 44

PE semi gloss, UV resistant

White, translucent

Built-In LED Unit (removable)

Multicolor & warm white 2700 K,
cool white 6000 K LEDs, max. 7.2 W,
max. 810 lm, life span: 30000 h

IR

3.7 V, 2 x 2600 mAh (Li-Ion)/ 10 Std.
11 Std.

100-240 V~, 50/60 Hz, Vout 5 V, 1,2 A

1,2 m

100-240 VAC, 50/60 Hz

III (Product), II (Charger)

-

IP 54

PE satiné, résistant aux rayons UV

Blanc, translucide

1x E27/ max. 40 W E27

illuminant à DEL E27,
max. 5,5 W, CE: F, max. 500 lm
Durée de vie: 15.000 h

-

-

-

env. 4,6 m, noir

230 V~, 50Hz

II

-

IP44

PE satiné, résistant aux rayons UV

Blanc, translucide

1x E27/ max. 40 W E27

LED multicolours E27,
max. 9 W, CE: F, max. 850 lm,
Durée de vie: 50.000 h

avec télécommande radio

-

-

env. 4,6 m, noir

230 V~, 50 Hz

II

-

IP44

PE satiné, résistant aux rayons UV

Blanc, translucide

Unité à LED intégrée (amovible)

DEL multicolores & blanc chaud 2700
K, blanc froid 6000 K, max. 7,2 W,
max. 810 lm, durée de vie: 30000 h

IR

3.7 V, 2 x 2600 mAh (Li-Ion)/ 10 Std.
11 Std.

100-240 V~, 50/60 Hz, Vout 5 V, 1,2 A

1,2 m

100-240 VAC, 50/60 Hz

III (Produit), II (Chargeur)

-

IP54

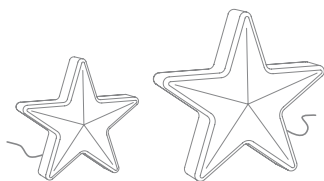

Modell | Model | Modèle

STAR 40
(STAR 40 LED OUTDOOR)
MOD. 05-04-40

STAR 60
(STAR 60 LED OUTDOOR)
MOD. 05-04-60



DE	Material	PE, matt	PE, matt
	Farbe	Weiß, transluzent	Weiß, transluzent
	Maße	B 41 x L 10 x H 40	B 57 x L 13 x H 55 cm
	Gewicht	1 kg	2 Kg
	Lampenfassung	EINGEBAUTE LED-Einheit (ausbaubar)	EINGEBAUTE LED-Einheit (ausbaubar)
	Leuchtmittel	Multicolor-LEDs, max. 3 W, max. 142 lm, EEK: G Lebensdauer: 30000 h	Multicolor-LEDs, max. 3 W, max. 168 lm, EEK: G Lebensdauer: 30000 h
	Fernbedienung	IR	IR
	Aufladbarer Akku/ Ladezeit Laufzeit (in Farbwechsel)	-	-
	Ladegerät/ Kabel	-	-
	Verkabelung	1,8 m, schwarz	1,8 m, schwarz
	Spannung	100-240 VAC, 50/60 Hz, Vout 5 V, 1 A	100-240 VAC, 50/60 Hz, Vout 5 V, 1 A
	Schutzklasse	III (Produkt), II (Netzteil)	III (Produkt), II (Netzteil)
	Für Außenbereich	IP44	IP44
EN	Material	PE matte finish	PE matte finish
	Colour	White, translucent	White, translucent
	Dimensions	W41 x L10 x H40	W57 x L13 x H55 cm
	Weight	1 kg	2 Kg
	Lamp Holder	Built-In LED Unit (removable)	Built-In LED Unit (removable)
	Illuminant	Multicolour LEDs, max. 3 W, max. 142 lm, EEC: G life span: 30000 h	Multicolour LEDs, max. 3 W, max. 168 lm, EEC: G life span: 30000 h
	Remote Control	IR	IR
	Rechargeable battery/ ChargingTime Runtime (in colour change)	-	-
	Charger/ Cable	-	-
	Cable	1,8 m, black	1,8 m, black
	Voltage	100-240 VAC, 50/60 Hz, Vout 5 V, 1 A	100-240 VAC, 50/60 Hz, Vout 5 V, 1 A
	Protection Class	III (Product), II (Charger)	III (Product), II (Charger)
	For Outdoor Use	IP44	IP44
FR	Matériaux	PE matte finition	PE matte finition
	Couleur	Blanc, translucide	Blanc, translucide
	Dimensions	La 41 x L 10 x H 40	La 57 x L 13 x H 55 cm
	Poids	1 kg	2 Kg
	Support de Lampe	Unité à LED intégrée (amovible)	Unité à LED intégrée (amovible)
	Ampoule	Multicolore LED, max. 3 W, max. 142 lm, CÉ: G Durée de vie: 30000 h	Multicolore LED, max. 3 W, max. 168 lm, CÉ: G Durée de vie: 30000 h
	Télécommande	IR	IR
	Batterie/ Temps de Charge Autonomie (en changement de couleur)	-	-
	Chargeur/ Câblage	-	-
	Câblage	1,8 m, noir	1,8 m, noir
	Tension	100-240 VAC, 50/60 Hz, Vout 5 V, 1 A	100-240 VAC, 50/60 Hz, Vout 5 V, 1 A
	Catégorie	III (Produit), II (Alimentation électrique)	III (Produit), II (Alimentation électrique)
	Pour Utilisation Extérieure	IP44	IP44

STAR 40

(STAR 40 LED ACCU OUTDOOR)
MOD. 05-02-40



PE, matt	PE, matt
Weiß, transluzent	Weiß, transluzent
B 41 x L 10 x H 40	B 57 x L 13 x H 55 cm
1 kg	2 Kg
EINGEBAUTE LED-Einheit (ausbaubar)	EINGEBAUTE LED-Einheit (ausbaubar)
Multicolor-LEDs, max. 3 W, max. 142 lm, EEK: G Lebensdauer: 30000 h	Multicolor-LEDs, max. 3 W,max. 168 lm, EEK: G Lebensdauer: 30000 h
IR	IR
3.7 V austauschbar, 6 h 7 h	3.7 V austauschbar, 6 h 7 h
Vout 5 V, 1 A/ 1,8 m, weiß	Vout 5 V, 1 A/ 1,8 m, weiß
-	-
110-240 V~, 50-60 Hz	110-240 V~, 50-60 Hz
III (Produkt), II (Ladegerät)	III (Produkt), II (Ladegerät)
IP44	IP44

PE matte finish	PE matte finish
White, translucent	White, translucent
W41 x L 10 x H 40	W57 x L 13 x H55 cm
1 kg	2 Kg
Built-In LED Unit (removable)	Built-In LED Unit (removable)
Multicolour LEDs, max. 3 W, max. 142 lm, EEC: G life span: 30000 h	Multicolour LEDs, max. 3 W,max. 168 lm, EEC: G life span: 30000 h
IR	IR
3.7 V replaceable, 6 h 7 h	3.7 V replaceable, 6 h 7 h
Vout 5 V, 1 A/ 1,8 m, white	Vout 5 V, 1 A/ 1,8 m, white
-	-
110-240 V~, 50-60 Hz	110-240 V~, 50-60 Hz
III (Product), II (Charger)	III (Product), II (Charger)
IP44	IP44

PE matte finition	PE matte finition
Blanc, translucide	Blanc, translucide
La41 x L 10 x H40	La57 x L 13 x H55 cm
1 kg	2 Kg
Unité à LED intégrée (amovible)	Unité à LED intégrée (amovible)
Multicolore LED, max. 3 W, max. 142 lm, CÉ: G Durée de vie: 30000 h	Multicolore LED, max. 3 W, max. 168 lm, CÉ: G Durée de vie: 30000 h
IR	IR
3.7 V remplaçable, 6 h 7 h	3.7 V remplaçable, 6 h 7 h
Vout 5 V, 1 A/ 1,8 m, blanc	Vout 5 V, 1 A/ 1,8 m, blanc
-	-
110-240 V~, 50-60 Hz	110-240 V~, 50-60 Hz
III (Produit), II (Chargeur)	III (Produit), II (Chargeur)
IP44	IP44



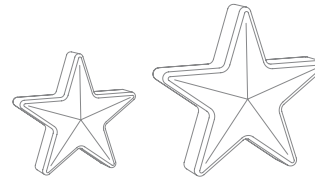

STAR 60

(STAR 60 LED ACCU OUTDOOR)
MOD. 05-02-60



9W RGBW BULB, REMOTE CONTROL



Modell Model Modèle	9W MULTICOLOUR LED LIGHTBULB 20-02-01	REMOTE CONTROLLER (2.4 GHZ) 20-02-02
	   	
DE Material	Aluminium, Kunststoff	Kunststoff
Farbe	silber, weiß	weiß
Maße	Ø ca. 60 mm, H 122 mm	B 53 x L x 120 x H 20 mm
Gewicht	ca. 0,12 kg	53 g
Energieeffizienz-Klasse/ Lumen	F/ Lm: Max. 850 (weiß)	-
Leuchtmittel	Multicolor LED Leuchtmittel E27, MAX. 9 W, Lebensdauer: 50.000 h	-
Fernbedienung/ Batterien	Mod. 20-02-02 wird benötigt	Funk 2.4 GHz/ 2 x AAA (nur Alkaline)
Spannung	AC 85-240 V, 50-60 Hz	-
Funktionen	<ul style="list-style-type: none"> • 9 Programme • Multicolor + Warm-weißes Licht • Dimmfunktion • 4-Kanal-Steuerung • Reichweite bis zu 25 m • Kompatibel mit iOS™ und Android™ (mit WIFI-Controller Mod. 20-02-03) 	<ul style="list-style-type: none"> • 9 voreingestellte Farben • Dimmfunktion • Multicolor • Warm-weißes Licht • 4-Kanal-Steuerung • Reichweite bis zu 25 m
EN Material	Aluminium, plastic	Plastic
Colour	silver, white	white
Dimensions	Ø approx. 60 mm, H 122 mm	W 53 x L x 120 x H 20 mm
Weight	approx. 0.12 kg	53 g
Energy Class/ Lumens	F/ Lm: Max. 850 (white)	-
Illuminant	LED multicolor light bulb E27, MAX 9 W, Life span: 50.000 h	-
Remote Control/ Battery	Mod. 20-02-02 is needed	Radio 2.4 GHz/ 2 x AAA (Alkaline only)
Voltage	AC 85-240 V, 50-60 Hz	-
Functions	<ul style="list-style-type: none"> • 9 programmes • Multicolor + Warm white light • Dimmable • 4 Channel controls • A range of up to 25 m • Compatible with iOS™ and Android™ (with Moree WIFI Controller Mod. 20-02-03) 	<ul style="list-style-type: none"> • 9 programmes • Brightness Control • Multicolour • Warm white light setting • 4 Channel controls • A range of up to 25 meters
FR Matériaux	Aluminium, plastique	Plastique
Couleur	argentée, blanc	blanc
Dimensions	Ø env. 60 mm, H 122 mm	La 53 x Lo x 120 x H 20 mm
Poids	env. 0,12 kg	53 g
Classe Énergétique/ Lumens	F/ Lm: Max. 850 (blanc)	-
Ampoule	Ampoule LED multicolours, E27, MAX 9 W, Durée de vie: 50.000 h	-
Télécommande/ Batterie	Mod. 20-02-02 est nécessaire	Radio contrôle 2.4 GHz/ 2 x AAA (seulement Alcalin)
Tension	AC 85-240 V, 50-60 Hz	-
Fonctions	<ul style="list-style-type: none"> • 9 programmes • Multicolours + Lumière blanche • Contrôle d'intensité • 4 Channel controls • Une gamme de jusqu'à 25 m • Compatible avec iOS™ et Android™ (avec Moree Wifi Contrôleur) 	<ul style="list-style-type: none"> • 9 programmes • Fonction de gradation • Multicolore • Lumière blanche chaude • 4 contrôles sur 4 canaux • Portée jusqu'à 25 m

11W WIFI RGB CCT BULB



11W RGB CCT LIGHTBULB

Modell | Model | Modèle



















20-03-01



DE	Beschreibung	WIFI LED RGB & CCT Leuchtmittel
	Material/ Farbe	Aluminium, weiß/ Kunststoff opak
	Maße/ Gewicht	Ø ca. 70 mm, H 130 mm/ ca. 70 g
	Energieeffizienz-Klasse	F
	Leistung/ Lebensdauer	MAX. 11 W/ 25.000 h
	Spannung/ Lampenhalter	220-240 V, 50 Hz/ E27
	Lichtfarben/ Lumen	Multicolor/ Warm-Kaltweiß einstellbar (2700 - 6500 K), max 1050 lm
	Fernbedienung	Per Smartphone mit Moree Mobile Remote-App (Android & IOS)
	Funktionen	<ul style="list-style-type: none"> • Szenen- und Farbprogramme • Multicolor & Weißlicht-Einstellungen • Eingebautes WLAN-Modul • Zeitschalter per App • Dimm-Funktion per App • Kompatibel mit Google Home und Amazon Echo über Sprachsteuerung
EN	Description	WIFI LED multicolor & white light bulb
	Material/ Colour	Aluminium, white/ plastic, opaque
	Dimensions/ Weight	Ø approx. 70 mm, H 130 mm/ approx. 70 g
	Energy Class	F
	Power/ Lifespan	MAX. 11 W/ 25.000 h
	Voltage/ Lamp holder	220-240 V, 50-60 Hz/ E27
	Light colours/ Lumens	Multicolour/ warm & cold white 2700-6500 K, max 1050 lm
	Remote Control	With smartphone by Moree Mobile Remote app (Android & IOS)
	Functions	<ul style="list-style-type: none"> • Scene and colour programmes • Multicolor & white light settings • Built in wifi controller • Timing switch via app • Dimming function via App • Compatible with voice control via Google home & Amazon Echo
FR	Description	WIFI LED ampoule multicolore & blanche
	Matériaux/ Couleur	Aluminium, blanc/ plastique opaque
	Dimensions/ Poids	Ø env. 70 mm, H 130 mm/ env. 70 g
	Classe Énergétique	F
	Puissance/ Durée de vie	MAX. 11 W/ 25.000 h
	Tension/ Support de lampe	220-240 V, 50 Hz/ E27
	Couleurs de la lumière/ Lumen	Multicolore/ blanc chaud et froid 2700-6500 K, max 1050 lm
	Télécommande	Avec smartphone par l'application Moree Mobile Remote (Android et IOS)
	Fonctions	<ul style="list-style-type: none"> • Programmes de scènes et de couleurs • Paramètres de lumière multicolores et blancs • Module WIFI intégré • Interrupteur de synchronisation via l'application • Fonction dimmable par l'application • Compatible avec Google Home et Amazon Echo via contrôle vocal

LEGENDE TECHNISCHE SPEZIFIKATIONEN

LEGEND TECHNICAL SPECIFICATIONS | LÉGENDE CARACTERISTIQUES TECHNIQUES

						
E27 Fassung	LEDs warmweiss	LED-Leuchtmittel (Multicolor & Weiß)	Beleuchtung für Vorderseite & Arbeitsplatz	Eingebaute LED-Einheit (austauschbar)	LED-Einheit mit Schnellverschluss, magnetisch	
E27 socket	LEDs warmwhite	LED source (Multicolor & White)	Front & workspace illumination	Built-In LED Unit (replacable)	LED unit with fast lock (magnetic)	
E27 douille de lampe	LED blanc chaud	Lampes LED (Multicolore et blanc)	Lumière pour avant et espace de travail	Unité à LED intégrée (échangeable)	Unité LED avec fixation magnétique	
						
Produkt mit Kabel	USB Port/Netzteil	Produkt mit Batterie	Solarmodul	Induktions-Ladestation	Dimmbar	
Product with cable	USB Port/Adapter	Product with battery	Solar panel	Induction charging station	Dimmable	
Produit avec câble	USB Port/Alimentation	Produit avec batterie	Panneau solaire	Station de charge à induction	Dimmable	
						
Verwendung im Innenbereich	Verwendung im Aussenbereich	Schutzart	Kabel-Stauraum	Variable Höhe	Magnetischer Schnellverschluss	Mit Fernbedienung
Indoor use	Outdoor use	Ingress protection	Cable Organizer	Variable Height	Fast lock (magnetic)	With remote control
Pour utilisation intérieur	Pour utilisation extérieur	Indice de protection	Stockage Câble	Hauteur variable	Fixation magnétique	Avec télécommande



COMPATIBLE WITH
GOOGLE HOME™

COMPATIBLE WITH
ALEXA™

Die Produkte Google Home/ Amazon ALEXA können zur Steuerung des 11W WLAN Moree-Leuchtmittels über Sprachbefehle durch Google Home App/ Amazon Alexa App in Kombination mit der **Moree Mobile Remote App** verwendet werden, die im iOS App Store oder Android Google Play verfügbar ist.

The products Google Home/ Amazon ALEXA can be used to control the Moree WIFI 11W Smart bulb through voice command via the Google Home app/ Amazon Alexa app in combination with the **Moree Mobile Remote app**, available on the iOS App Store or Android Google Play.

Les produits Google Home/ Amazon ALEXA peut être utilisé pour contrôler 11W l'ampoule Moree WIFI par commande vocale via Google Home app/ Amazon Alexa app en combinaison avec l'**application Moree Mobile Remote**, disponible sur l'iOS App Store ou Android Google Play.

KONTAKT

CONTACT | A CONTACTER

DE

MOREE Germany GmbH
Kaiserswerther Markt 11
40489 Düsseldorf
Deutschland

AUSSTELLUNG

An St. Swibert 42
40489 Düsseldorf
Deutschland

KUNDENSERVICE

Tel. +49 (0)211 302 768-0
Montag – Freitag 9-17:30
info@moree.de | www.moree.de

EN

MOREE Germany GmbH
Kaiserswerther Markt 11
40489 Düsseldorf
Germany

SHOWROOM

An St. Swibert 42
40489 Düsseldorf
Germany

CUSTOMER SERVICE

Tel. +49 (0)211 302 768-0
Monday - Friday 9 am-5:30 pm
info@moree.de | www.moree.de/en

FR

MOREE Germany GmbH
Kaiserswerther Markt 11
40489 Düsseldorf
Allemagne

SALE D'EXPOSITION

An St. Swibert 42
40489 Düsseldorf
Allemagne

SERVICE CLIENT

Tel. +49 (0)211 302 768-0
Du lundi au vendredi de 9 h à 17 h 30
info@moree.de | www.moree.de/fr

AKTUELLE INFORMATIONEN ZU UNSEREN
PRODUKTEN FINDEN SIE IM INTERNET:
www.moree.de

KATALOG RUNTERLADEN

<https://www.moree.de/download/katalog-flyer/>

MEDIEN

www.facebook.com/moree.de
www.instagram.com/moree_de/
www.moree.de/newsletter-abonnieren/

REFER TO OUR WEBSITE FOR THE LATEST
INFORMATION ABOUT OUR PRODUCTS:
www.moree.de/en

CATALOGUE DOWNLOAD

<https://www.moree.de/en/download/catalogue-flyer/>

MEDIA

www.facebook.com/moree.de
www.instagram.com/moree_de/
www.moree.de/en/subscribe-newsletter/

CONSULTEZ NOTRE SITE WEB POUR LES
PLUS RÉCENTES MISES-À-JOUR SUR NOS
PRODUITS: www.moree.de/fr

TÉLÉCHARGEMENT DU CATALOGUE

<https://www.moree.de/fr/telecharger/brochure-depliant/>

MEDIA

www.facebook.com/moree.de
www.instagram.com/moree_de/
www.moree.de/fr/subscribe-newsletter/

Moree® ist markenrechtlich geschützt.
Änderungen an den Produkten vorbehalten. Jegliche
Haftung für den Fall von Irrtümern oder Auslassungen
wird ausgeschlossen.
Apple, das Apple-Logo und iPhone sind Warenzeichen
von Apple Inc., welche in den USA und anderen
Ländern eingetragen sind. App Store ist eine
Dienstleistungsmarke von Apple Inc..
Android ist ein Warenzeichen von Google Inc..
Amazon, Alexa und alle damit verbundenen Logos
sind Marken von Amazon.com, Inc. oder dessen
Tochtergesellschaften.
Unsere Dienste und Produkte werden nicht von Google
Inc. erstellt, mit ihr verbunden oder von ihr unterstützt.

Moree® is a Registered Trademark.
Changes to the products are reserved. All liability in case
of errors or omissions is excluded.

Apple, the Apple logo and iPhone are trademarks of
Apple Inc., registered in the U.S. and other countries.
App Store is a service mark of Apple Inc..

Android is a trademark of Google Inc..

Amazon, Alexa and all related logos are trademarks of
Amazon.com, Inc. or its affiliates.
Our services and products are not created by, affiliated
with, or supported by Google Inc..

Moree® est une marque déposée.
Tous changements aux produits sont réservés. Toute
responsabilité en cas d'erreur ou d'omission est exclue.

Apple, le logo Apple et iPhone sont des marques d'Apple
Inc., déposées aux États-Unis et d'autres pays. App
Store est une marque de service d'Apple Inc..

Android est une marque déposée de Google Inc..

Amazon, Alexa et tous les logos associés sont des
marques déposées d'Amazon.com, Inc. ou de ses filiales.
Nos services et produits ne sont pas créés, affiliés ou
pris en charge par Google Inc..

moree®
ENHANCING AMBIANCE



www.moree.de/en



moree®
ENHANCING AMBIANCE