

DAVE

ARTIFICIAL LEATHER COLLECTION

NEW!



Artificial Leather Collection
Valencia™ by Spradling

- DAVE bar stool in 2 frame versions:
- 360° swivelling & height-adjustable or static
- Upholstered seat with fabric cover made of imitation leather
- Imitation leather from Spradling® available in 66 colours
- Powder-coated frame in white or anthracite
- Easy to clean surfaces
- Protection against viruses, bacteria, stains and abrasion
- certified according to ISO 18184 and ISO 21702
- Bacteriostatic properties in accordance with ISO 22196
- perfect upholstery solution for hotels and transport areas

DAVE

ARTIFICIAL LEATHER COLLECTION

NEW!



MOD 42-03-06
DAVE Adjustable White/White/Leather

MOD 42-04-05
DAVE Adjustable Anthracite/Graphite/Leather

Please see the additional 64 artificial leather colours in the collection on the next 2 pages.

DAVE ARTIFICIAL LEATHER COLLECTION

NEW!

We will be glad to send you a sample folder of the imitation leather colours by post.

More information on artificial leather here: www.spradling.eu/de/kollektionen/valencia



107-2113
LOTUS



107-8020
PEARLESSENCE (MET.)



107-6020
GOLD (MET.)



107-0034
TAUPE

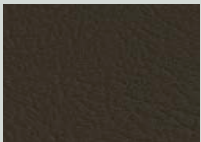

107-5002
MOSS

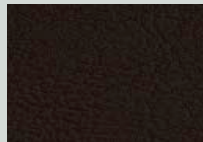

107-4041
METEOR



107-0020
MOCCA

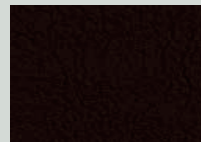

107-0001
PRALINÉ

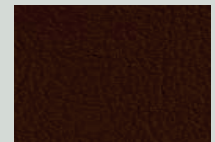

107-0033
BUCHE

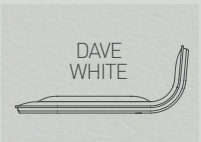

107-9607
PURE WHITE

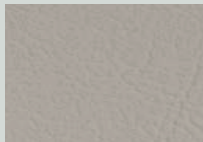

107-8032
WEISS

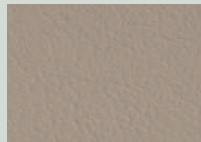

107-1048
SISAL

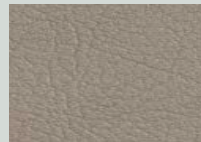

107-1020
IVORY (MET.)

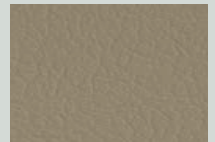

107-1049
LEINEN

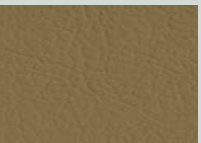

107-1001
CHAMPAGNE

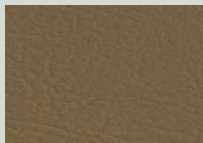

107-1050
BEIGE

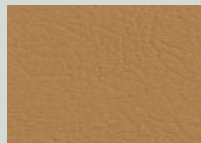

107-2117
CASHMERE

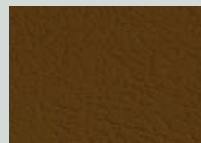

107-0002
COGNAC

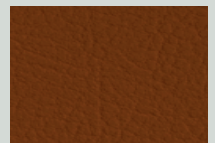

107-0035
TERRACOTTA

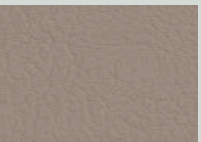

107-4044
WARM GREY

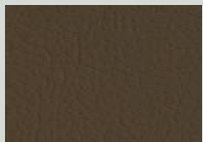

107-4001
MUSHROOM

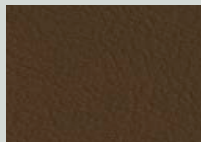

107-9001
SUMATRA



107-2115
CHESTNUT

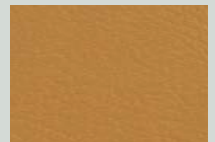

107-2116
CAMEL



107-2001
MERLOT

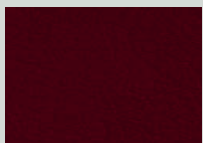

107-2062
PORT



107-2074
KIRSCHÉ

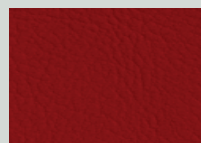

107-2075
ROT

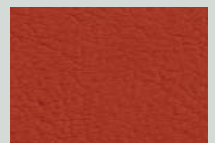

107-2112
TOMATO



Also available in BS 5852 Part 2 CRIB 5 quality

Also available in DIN 4102 B1 & NF P 92-503 M1 quality

We will be glad to send you a sample folder of the imitation leather colours by post.

More information on artificial leather here: www.spradling.eu/de/kollektionen/valencia





107-4040 AUSTER  

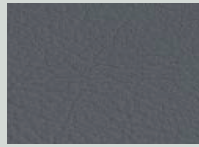

107-4020 SILVER (MET.) 



107-4045 PERLE  

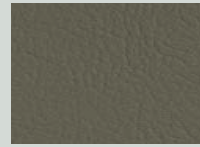

107-4002 LAUREL 

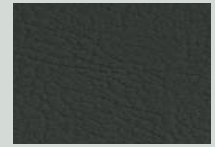

107-4052 LICHTGRAU 

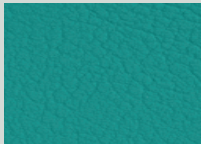

107-5056 JADE 



107-5057 TÜRKIS 



107-3069 BALTIC 





107-3001 LAVENDEL 



107-2118 ULTRA VIOLET 



107-2119 TEAL  



107-5069 GRÜN 

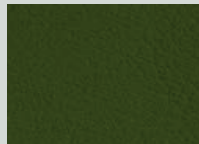

107-5001 OLIVE 

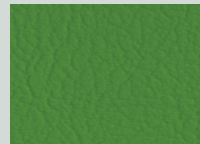

107-5041 APFEL 

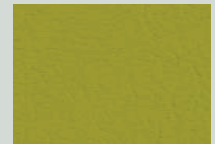

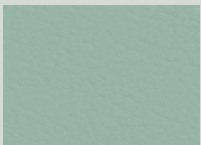

107-2110 AVOCADO  





107-2106 CORAL 

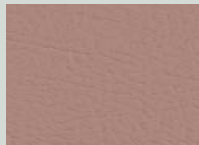

107-2107 SKYLIGHT  



107-2114 ROSÉ  



107-2021 PINK 

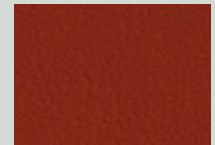



107-6003 NECTARINE

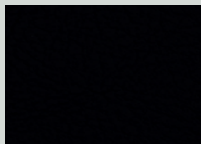

107-4003 GRAPHITE  



107-9035 SCHWARZ  

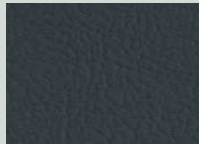

107-4043 PLATIN 





107-5065 PETROL 



107-4042 TITAN 





107-2002 BERRY  

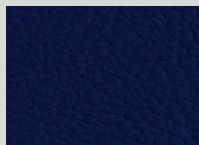

107-7001 AMETHYST 



107-3067 DELFT  

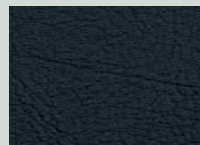



107-2108 NIGHT



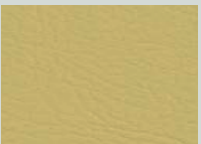

107-3068 MARINE

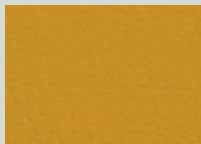

107-2109 CITRUS  



107-2111 SQUASH  

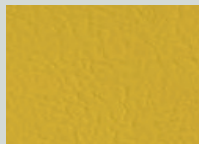

107-2020 SONNE 





107-6012 SAFRAN 



107-6013 MELONE 



107-6019 ORANGE  

 Also available in BS 5852 Part 2 CRIB 5 quality

 Also available in DIN 4102 B1 & NF P 92-503 M1 quality

DAVE

HEIGHT ADJUSTABLE

MOD. 42-03-YY DAVE white/selected leather colour
 MOD. 42-04-YY DAVE anthracite/selected leather colour

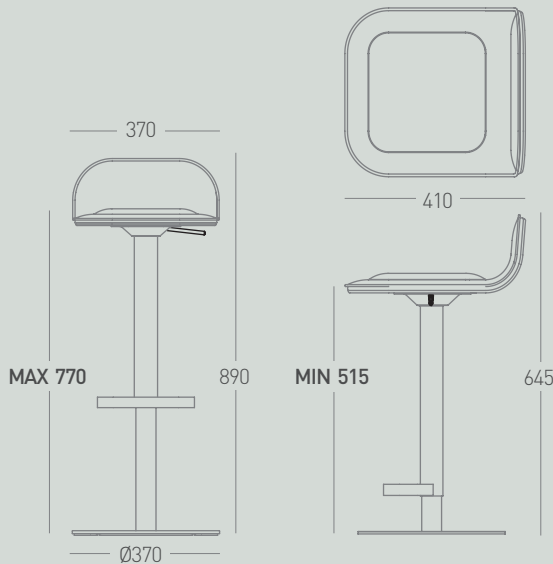

DAVE

STATIC

MOD. 42-01-YY DAVE white/selected leather colour
 MOD. 42-02-YY DAVE anthracite/selected leather colour

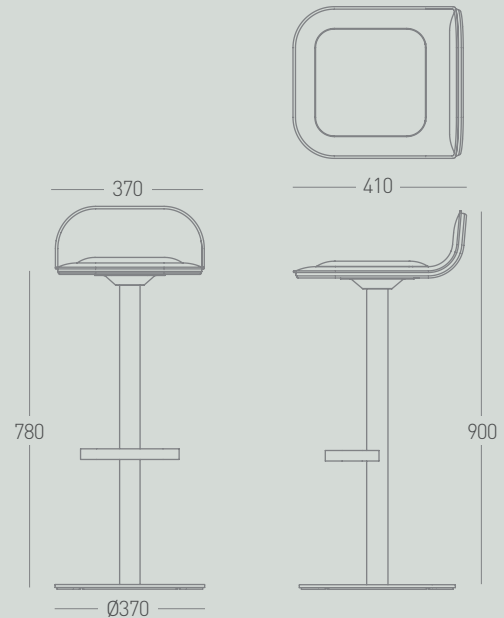

Barstool Specification (height-adjustable)

Dimensions D 41 x W 37 x H 89 cm
 Seat height MAX. / MIN. 77-51.5 cm (infinitely adjustable)
 Frame material Centre section: powder-coated steel
 Base plate: Powder-coated steel
 Frame colour White or anthracite, matt
 Seat material Moulded wood with artificial leather, upholstered
 Seat colour 66 leather colours available
 Seat weight 13 kg
 Area of application Home & Contract



Barstool Specification (staticS)

Dimensions D 41 x W 37 x H 90 cm
 Seat height 78 cm / static / not rotatable
 Frame material Centre section: powder-coated steel
 Base plate: powder-coated steel
 Frame colour White or anthracite, matt
 Seat material Moulded wood with artificial leather, upholstered
 Seat colour 66 leather colours available
 Seat weight 10 kg
 Area of application Home & Contract



Specification Seat

Dimensions D 41 x W 37 x H 12 cm
 Material Moulded wood, upholstered
 Seat colour 66 colours available on request
 Fabric cover Backing material: 100% cotton with vinyl/urethane coating
 Material protection/coating PERMABLOK3® coated
 >300,000 Martindale cycles (EN ISO 12947:1999 Part 2)
 UV resistance: ISO 105 B02 ≥ 7/8
 EN 71-3 Safety of toys
 Resistance to cold breakage -23 °C
 Antibacterial protection
 Stain-resistant surface
 Mould-resistant backing layer and surface
 Resistance to sulphide stains
 Antistatic surface
 Sustainability Carbon Neutral Certified
 EcoSense, Greenguard Certified
 Indoor Air Emissions A+ Certified
 Indoor Air Quality Certified
 ISO 14001 Certified, ISO 45001 Certified
 Reach Compliant, RoHs Compliant

Flame retardant standards AT: ÖNORM A 3800 Part 1, Smoke formation class Q1 - low smoke emission
 AT: ÖNORM B 3825, Group 1 - low flammability behaviour
 DE: DIN 4102 B2
 ES: UNE 23.727-90 1R/M.2
 EU: EN 1021 Part 1 and 2
 FR: NF D 60-013 (art. AM 18)
 FR: NF P 92-503/M2
 IT: UNI 9175 (1987) / UNI 9175/FA1 (1994)
 Classe 1.1M (UNO I EMME)
 UK: BS 5852 Part 2 CRIB 5
 UK: BS 7176 Medium Hazard
 US: CAL TB 117-2013, Section E
 US: FAR 25/853, US: FMVSS 302
 US: NFPA 260 - Class 1

Application Catering
 Hotels and catering
 Healthcare
 Offices
 Public areas
 Residential area



2404_10 Dave Artificial Leather Collection EN ©2024 Moree Germany GmbH

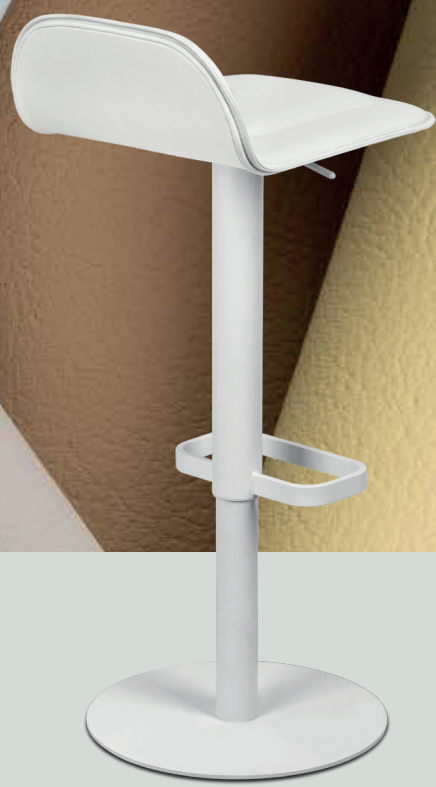

ADMINISTRATION
Moree Germany GmbH
Kaiserswerther Markt 11
40489 Düsseldorf, Germany

www.moree.de
info@moree.de
T +49 (0)211 302 768 0

SHOWROOM
An St. Swibert 42
40489 Düsseldorf, Germany

LOGISTICS & PRODUCTION
Moree Germany GmbH
Beule 76-78
42277 Wuppertal, Germany

moree®