

DAVE KUNSTLEDER-KOLLEKTION

NEU!



Kunstleder-Kollektion
Valencia™ by Spradling

- DAVE Barhocker in 2 Gestellversionen:
360° drehbar & höhenverstellbar oder statisch
- Gepolsterter Sitz mit Bezug aus Kunstleder
- Kunstleder von Spradling® in 66 Farben erhältlich
- Gestell pulverbeschichtet in Weiß oder Anthrazit
- leicht zu reinigende Oberflächen
- Schutz gegen Viren, Bakterien, Flecken und Abrieb
- nach ISO 18184 und ISO 21702 zertifiziert
- bakterio-statischen Eigenschaften nach ISO 22196
- perfekte Polsterlösung für Hotels und Verkehrsbereiche

DAVE KUNSTLEDER-KOLLEKTION

NEU!



MOD 42-03-06
DAVE Adjustable White/White/Leather

MOD 42-04-05
DAVE Adjustable Anthracite/Graphite/Leather

Bitte sehen Sie weitere 64 Kunstlederfarben der Kollektion auf den nächsten 2 Seiten.

DAVE KUNSTLEDER-KOLLEKTION

NEU!

Eine Muster-Mappe der Kunstleder-Farben senden wir Ihnen gerne per Post.

Mehr Information zum Kunstleder hier: www.spradling.eu/de/kollektionen/valencia

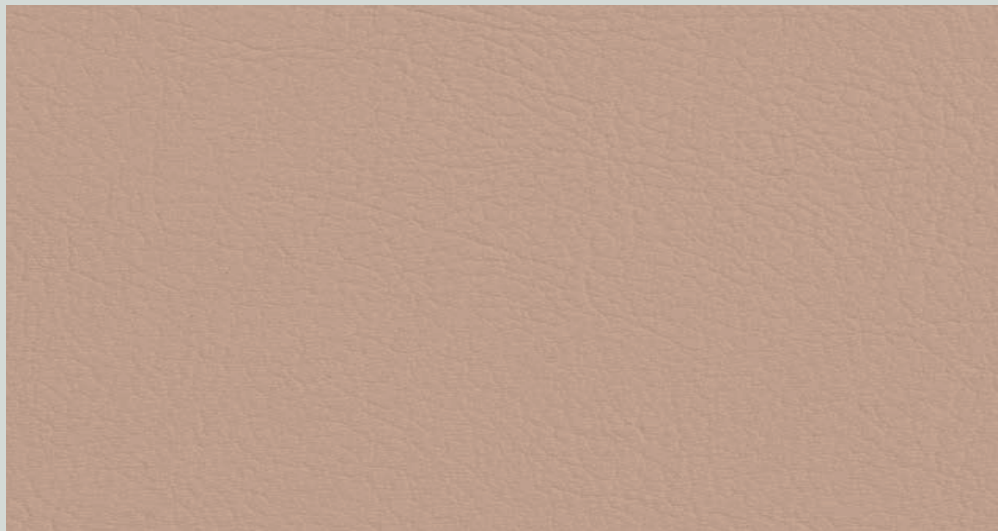

107-2113
LOTUS

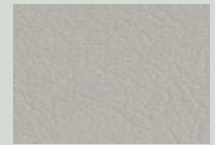

107-8020
PEARLESSENCE (MET.)

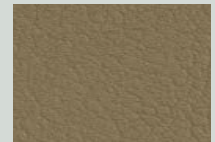

107-6020
GOLD (MET.)

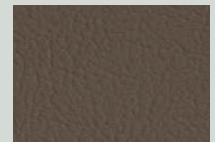

107-0034
TAUPE

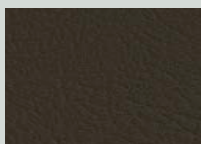

107-5002
MOSS

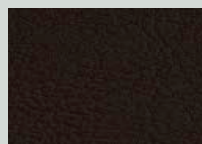

107-4041
METEOR



107-0020
MOCCA

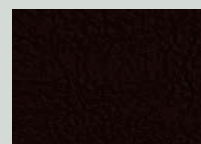

107-0001
PRALINÉ

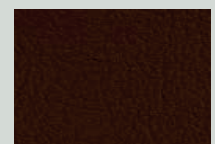

107-0033
BUCHE



107-9607
PURE WHITE

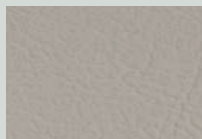

107-8032
WEISS

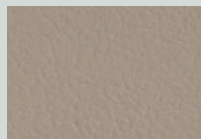

107-1048
SISAL

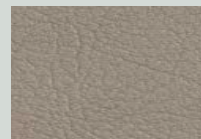

107-1020
IVORY (MET.)

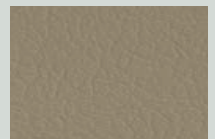

107-1049
LEINEN

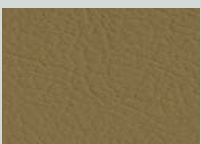

107-1001
CHAMPAGNE

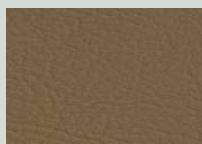

107-1050
BEIGE

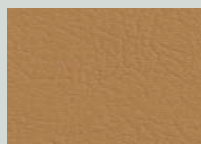

107-2117
CASHMERE

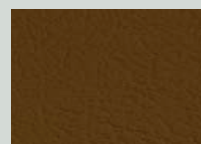

107-0002
COGNAC

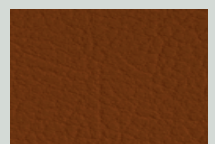

107-0035
TERRACOTTA

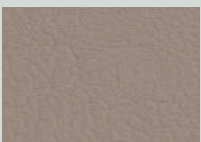

107-4044
WARM GREY

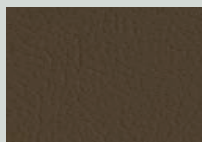

107-4001
MUSHROOM

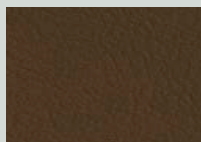

107-9001
SUMATRA

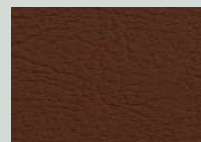

107-2115
CHESTNUT

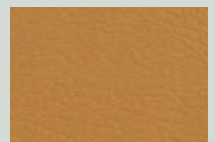

107-2116
CAMEL



107-2001
MERLOT

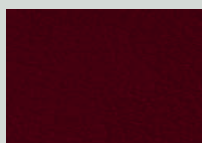

107-2062
PORT



107-2074
KIRSCHÉ



107-2075
ROT

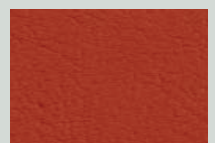

107-2112
TOMATO

☞ Auch in BS 5852 Teil 2 CRIB 5 Qualität erhältlich

☞ Auch erhältlich in DIN 4102 B1 & NF P 92-503 M1 Qualität



DAVE KUNSTLEDER-KOLLEKTION

NEU!

Eine Muster-Mappe der Kunstleder-Farben senden wir Ihnen gerne per Post.

Mehr Information zum Kunstleder hier: www.spradling.eu/de/kollektionen/valencia





107-4040 AUSTER  



107-4020 SILVER (MET.) 



107-4045 PERLE  



107-4002 LAUREL 

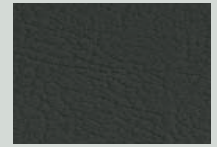

107-4052 LICHTGRAU 

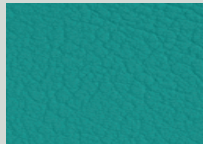

107-5056 JADE 



107-5057 TÜRKIS 



107-3069 BALTIC 





107-3001 LAVENDEL 



107-2118 ULTRA VIOLET 



107-2119 TEAL  



107-5069 GRÜN 



107-5001 OLIVE 

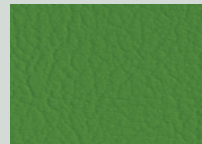

107-5041 APFEL 

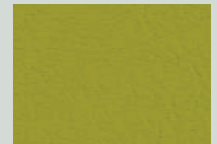

107-2110 AVOCADO  

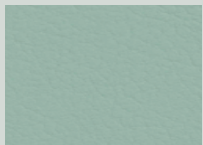



107-2106 CORAL 

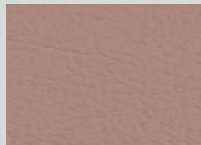

107-2107 SKYLIGHT  



107-2114 ROSÉ  

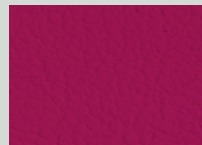

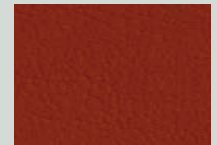

107-2021 PINK 



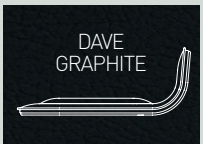

107-6003 NECTARINE

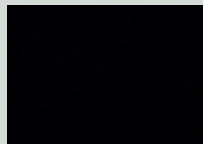

107-4003 GRAPHITE  



107-9035 SCHWARZ  

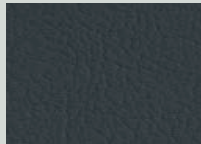

107-4043 PLATIN 



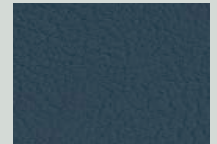

107-5065 PETROL 



107-4042 TITAN 



107-2002 BERRY  



107-7001 AMETHYST 



107-3067 DELFT  

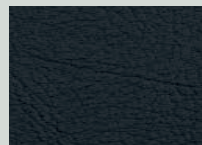



107-2108 NIGHT



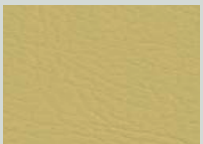

107-3068 MARINE

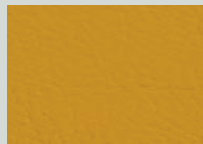

107-2109 CITRUS  



107-2111 SQUASH  

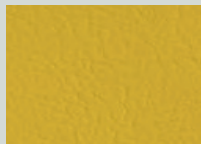

107-2020 SONNE 





107-6012 SAFRAN 



107-6013 MELONE 



107-6019 ORANGE  

 Auch in BS 5852 Teil 2 CRIB 5 Qualität erhältlich

 Auch erhältlich in DIN 4102 B1 & NF P 92-503 M1 Qualität

DAVE HÖHENVERSTELLBAR

MOD. 42-03-YY DAVE Weiss/gewählte Lederfarbe
MOD. 42-04-YY DAVE Anthrazit/gewählte Lederfarbe

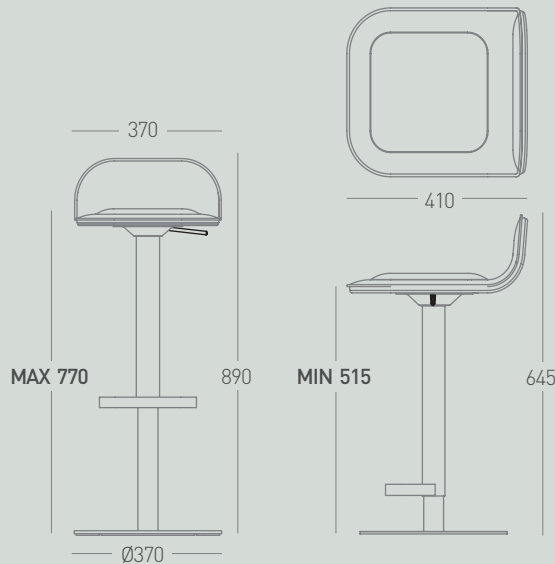

DAVE STATISCH

MOD. 42-01-YY DAVE Weiss/gewählte Lederfarbe
MOD. 42-02-YY DAVE Anthrazit/gewählte Lederfarbe

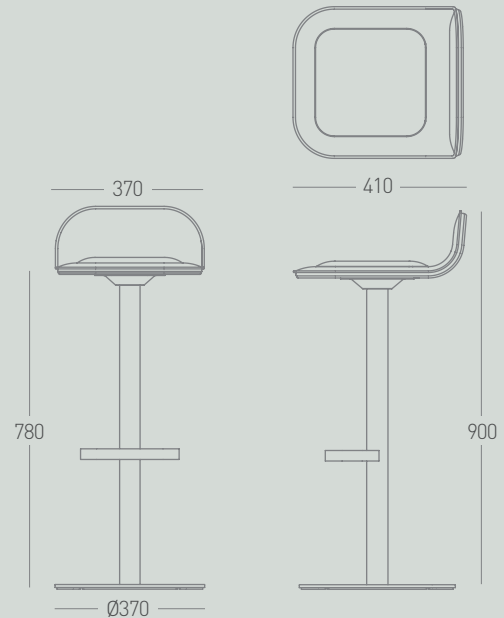

Spezifikation Barhocker (höhenverstellbar)

Dimensionen	T 41 x B 37 x H 89 cm
Sitzhöhe	MAX./MIN. 77-51,5 cm (stufenlos verstellbar)
Material Gestell	Mittelteil: Stahl pulverbeschichtet Bodenplatte: Stahl pulverbeschichtet
Farbe Gestell	Weiss oder Anthrazit, matt
Material Sitz	Formholz mit Kunstleder, gepolstert
Farbe Sitz	66 Lederfarben erhältlich
Gewicht	13 Kg
Anwendungsbereich	Home & Contract



Spezifikation Barhocker (statisch)

Dimensionen	T 41 x B 37 x H 90 cm
Sitzhöhe	78 cm/statisch/nicht drehbar
Material Gestell	Mittelteil: Stahl pulverbeschichtet Bodenplatte: Stahl pulverbeschichtet
Farbe Gestell	Weiss oder Anthrazit, matt
Material Sitz	Formholz mit Kunstleder, gepolstert
Farbe Sitz	66 Lederfarben erhältlich
Gewicht	10 Kg
Anwendungsbereich	Home & Contract



Spezifikation Sitz

Dimensionen	T 41 x B 37 x H 12 cm
Material	Formholz, gepolstert
Sitzfarbe	66 Farben auf Anfrage erhältlich
Stoffbezug	Trägermaterial: 100% Cotton mit Vinyl-/Urethan-Beschichtung
Materialschutz/ Beschichtung	PERMABLOK3® beschichtet >300 000 Martindale-Zyklen (EN ISO 12947:1999 Teil 2) UV-Beständigkeit: ISO 105 B02 > 7/8 EN 71-3 Sicherheit von Spielzeug Kältebruchresistenz -23 °C Antibakterieller Schutz Fleckenschutz-Oberfläche Schimmelbeständige Trägerschicht und Oberfläche Beständigkeit gegen Sulfid-Flecken Antistatische Oberfläche
Nachhaltigkeit	Carbon Neutral Certified EcoSense, Greenguard Certified Indoor Air Emissions A+ Certified Indoor Air Quality Certified ISO 14001 Certified, ISO 45001 Certified Reach Compliant, RoHs Compliant

Flammschutz-Normen	AT: ÖNORM A 3800 Teil 1, Qualmbildungsklasse Q1 - schwachqualmend AT: ÖNORM B 3825, Gruppe 1 - Schwerbrennbares Verhalten DE: DIN 4102 B2 ES: UNE 23.727-90 1R/M.2 EU: EN 1021 Teil 1 und 2 FR: NF D 60-013 (art. AM 18) FR: NF P 92-503/M2 IT: UNI 9175 (1987) / UNI 9175/FA1 (1994) Classe 1.1M (UNO I EMME) UK: BS 5852 Part 2 CRIB 5 UK: BS 7176 Medium Hazard US: CAL TB 117-2013, Section E US: FAR 25/853, US: FMVSS 302 US: NFPA 260 - Class 1
--------------------	--

Anwendung	Gastronomie Hotels Gesundheitswesen Büro Öffentliche Bereiche Wohnbereich
-----------	--



2004/10 Dave Kunstleder-Kollektion DE ©2024 Moree Germany GmbH

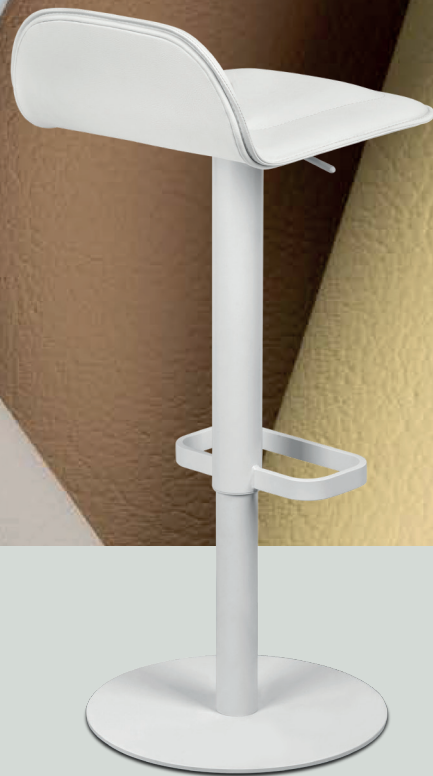

VERWALTUNG
Moree Germany GmbH
Kaiserswerther Markt 11
40489 Düsseldorf

www.moree.de
info@moree.de
T +49 (0)211 302 768 0

AUSSTELLUNG
An St. Swibert 42
40489 Düsseldorf

LOGISTIK & PRODUKTION
Moree Germany GmbH
Beule 76-78
42277 Wuppertal

moree®